



## Contents:

## Page:

Carbide Grade Selection	2
Type B inserts	2
Recommended cutting speed	3
Conversion of Cutting Speed to Rotational Speed	4
Number of passes and depth of cut per pass for multitooth insert	4
Number of threading passes selection for single point inserts	5

## Contents:

## Page:

Thread Turning Methods	5
Important Points about Carmex Threading Inserts	6
Flank Clearance Angle	6
Anvil Change Recommendation	7
Thread Turning - Step by Step	8-9
Troubleshooting	9
Threading Inserts Standards	10

## Carbide Grade Selection

Choose the Carmex grade specifically formulated for your application from the following list:  
**Coated Grades**

**HBA** (H10-H25) (S10-S25) Extra-fine sub-micron grade with high toughness, for optimized performance on hardened steels and cast iron up to 62HRC, titanium alloys and super alloys (Hästelloy, Inconel and Nickel based alloys).

**BLU** (M10-M20) (K05-K20) (N10-N20) (S10-S20) PVD triple layer coated sub-micron grade for stainless steels, cast iron, titanium, non ferrous metals and most of the high temperature alloys.

**BMA** (P20-P40) (K20-K30) PVD TiAlN coated sub-micrograin grade for stainless steels and exotic materials at medium to high cutting speeds.

**P25C** (P15-P35) PVD TiN coated grade for treated and hard alloy steels (25 HRc & up) at medium to low cutting speeds.

**MXC** (K10-K20) (P10-P25) PVD TiN coated micrograin for free cutting untreated alloy steels (below 30 HRc), for stainless steels and cast iron.

**BXC** (P30-P50) (K25-K40) PVD TiN coated grade for low cutting speed. Works well with wide range of stainless steels.

### Uncoated Grades

**P30\*** (P20-P30) Carbide grade for carbon and cast steels, works well at medium to low cutting speeds.

**K20\*** (K10-K30) Carbide grade for non ferrous metals, aluminum and cast iron.

\* Upon request

**Note:** Due to our unique and specialized production techniques, Carmex coated inserts provide superior cutting performance and exceptionally long tool life.

### Grade availability per inserts size

Grade	HBA	BLU	BMA	P25C	MXC	BXC	P30	K20
Insert sizes	11, 16, 22, 27	11, 16, 22	06, 08, 11, 16, 22, 27, 33U,	11, 16, 22, 27, 33U	11, 16, 22, 27, 33U	06, 08	11, 16, 22, 27, 33U	06, 08 11, 16, 22, 27, 33U
		Type-B 11, 16	Type-B 11, 16					

## Type B - Threading Inserts

A combination of ground profile, and sintered chip-breaker threading inserts. Unlike most other manufacturers inserts, this combination ensures a consistent high quality thread, with precise shape and dimensions. Two different unique styles of chip-breaker were designed to suit the different specific requirements of Internal threads and External threads. All of Carmex Type B inserts are made of Sub-Micrograin grade.

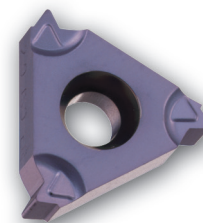

## Recommended cutting speed (ft/min) for thread turning inserts

ISO Standard	Material		Condition	Carbide Grades							
				HBA	BLU	BMA	P25C	MXC	BXC	K20	P30
P	Non-Alloy Steel and Cast Steel, Free Cutting Steel	<0.25%C	Annealed	360-690	390-590	330-590	390-590	230-490	165-425		
		≥0.25%C	Annealed								
		<0.55%C	Quenched & Tempered								
		≥0.55%C	Annealed								
			Quenched & Tempered								
	Low Alloy Steel and Cast Steel (less than 5% alloying elements)		Annealed Quenched & Tempered	295-460	260-425	230-394	230-390	195-295	165-260		
	High Alloy Steel, Cast Steel, and Tool Steel		Annealed Quenched & Tempered	230-295	195-260	165-195	180-230	165-195	130-165		
M	Stainless Steel and Cast Steel		Ferritic / Martensitic	360-525	295-425	195-295	195-295	165-260	165-260		
			Martensitic								
			Austenitic								
K	Cast Iron Nodular (GGG)		Ferritic / Pearlitic	390-490	330-425		260-360	195-295			
			Pearlitic								
	Grey Cast Iron (GG)		Ferritic Pearlitic	460-490	395-425		395-330	215-280			
	Malleable Cast Iron		Ferritic Pearlitic	360-460	330-425		260-330	195-280			
N	Aluminum-Wrought Alloy		Not Cureable		2300-3280			1970-2620	1480-1970	1970-2620	1150-1640
			Cured								
	Aluminum-Cast, Alloyed	≤12% Si	Not Cureable	920-2460				650-1800	490-1150	660-1800	360-985
			Cured								
			>12% Si	High Temperature							
Copper Alloys	>1% Pb		Free Cutting	625-1150				490-820	360-590	490-820	295-490
			Brass								
			Electrolytic Copper								
	Non Metallic		Duroplastics, Fiber Plastics					655-985	490-690	330-655	360-490
			Hard Rubber								
S	High Temp. Alloys, Super Alloys	Fe based	Annealed	65-260	100-215	80-195					
			Cured								
		Ni or Co based	Annealed								
			Cured								
			Cast								
	Titanium Alloys		Alpha +Beta Alloys Cured	100-195	130-165	115-145				115-145	
H	Hardened Steel		Hardened 45-50 HRC	100-195	130-165	115-145					
			Hardened 51-55 HRC								
			Hardened 56-62 HRC								
	Chilled Cast Iron		Cast	65-165	100-130	80-115					
	Cast Iron		Hardened	65-130	65-100	50-80					

## Conversion of Cutting Speed to Rotational Speed

Conversion of a selected cutting speed to rotational speed is calculated by the following formula:

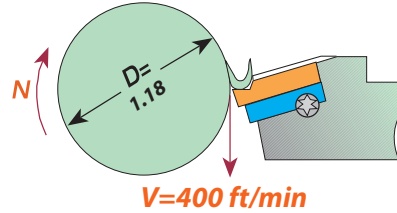

Example

$$N = \frac{V \times 12}{\pi \times D} = \frac{400 \times 12}{3.14 \times 1.18} = 1294 \text{ RPM}$$

## Number of passes and depth of cut per pass for multitooth insert

	Pitch mm / TPI	Insert Size		No. of Teeth	Ordering Code	No. of Passes	Depth of Cut per pass			
		L mm	I.C.				1	2	3	4
ISO External	1.00	16	3/8	3	16 ER 1.0 ISO 3M	2	.015	.010		
	1.50	16	3/8	2	16 ER 1.5 ISO 2M	3	.017	.012	.008	
	1.50	22	1/2	3	22 ER 1.5 ISO 3M	2	.022	.015		
	2.00	22	1/2	2	22 ER 2.0 ISO 2M	3	.022	.016	.011	
	2.00	22	1/2	3	22 ER 2.0 ISO 3M	2	.030	.019		
ISO Internal	3.00	27	5/8	2	27 ER 3.0 ISO 2M	4	.023	.020	.017	.013
	1.00	16	3/8	3	16 IR 1.0 ISO 3M	2	.013	.010		
	1.50	16	3/8	2	16 IR 1.5 ISO 2M	3	.015	.011	.008	
	1.50	22	1/2	3	22 IR 1.5 ISO 3M	2	.020	.015		
	2.00	22	1/2	2	22 IR 2.0 ISO 2M	3	.020	.014	.010	
UN External	2.00	22	1/2	3	22 IR 2.0 ISO 3M	2	.028	.018		
	3.00	27	5/8	2	27 IR 3.0 ISO 2M	4	.023	.018	.015	.012
	16	16	3/8	2	16 ER 16 UN 2M	3	.017	.012	.009	
	16	22	1/2	3	22 ER 16 UN 3M	2	.023	.015		
	12	22	1/2	2	22 ER 12 UN 2M	3	.023	.017	.012	
UN Internal	12	22	1/2	3	22 ER 12 UN 3M	2	.031	.020		
	8	27	5/8	2	27 ER 8 UN 2M	4	.024	.021	.018	.014
	16	16	3/8	2	16 IR 16 UN 2M	3	.017	.011	.009	
	16	22	1/2	3	22 IR 16 UN 3M	2	.022	.015		
	12	22	1/2	2	22 IR 12 UN 2M	3	.021	.015	.012	
Whitworth 55° External	12	22	1/2	3	22 IR 12 UN 3M	2	.029	.019		
	8	27	5/8	2	27 IR 8 UN 2M	4	.025	.020	.016	.012
	14	16	3/8	2	16 ER 14 W 2M	3	.020	.015	.011	
	14	22	1/2	3	22 ER 14 W 3M	2	.028	.030		
	11	22	1/2	2	22 ER 11 W 2M	3	.026	.019	.013	
Whitworth 55° Internal	14	16	3/8	2	16 IR 14 W 2M	3	.020	.015	.011	
	14	22	1/2	3	22 IR 14 W 3M	2	.028	.018		
	11	22	1/2	2	22 IR 11 W 2M	2	.026	.019	.013	
	14	16	3/8	2	16 ER 14 NPT 2M	3	.021	.018	.017	
	11.5	22	1/2	2	22 ER 11.5 NPT 2M	4	.019	.019	.017	.013
NPT External	11.5	27	5/8	3	27 ER 11.5 NPT 3M	4	.020	.019	.017	.012
	8	27	5/8	2	27 ER 8 NPT 2M	4	.029	.026	.024	.021
	14	16	3/8	2	16 IR 14 NPT 2M	3	.021	.018	.017	
	11.5	22	1/2	2	22 IR 11.5 NPT 2M	4	.019	.019	.017	.013
	11.5	27	5/8	3	27 IR 11.5 NPT 3M	4	.020	.019	.017	.012
API Round External	8	27	5/8	2	27 IR 8 NPT 2M	4	.029	.026	.024	.021
	10	22	1/2	2	22 ER 10 APIRD 2M	3	.024	.020	.012	
	10	27	5/8	3	27 ER 10 APIRD 3M	2	.039	.016		
	8	27	5/8	2	27 ER 8 APIRD 2M	3	.031	.024	.016	
	10	22	1/2	2	22 IR 10 APIRD 2M	3	.024	.020	.012	
API Round Internal	10	27	5/8	3	27 IR 10 APIRD 3M	2	.039	.016		
	8	27	5/8	2	27 IR 8 APIRD 2M	3	.031	.024	.016	

## Number of threading passes selection for single point inserts

Pitch:	mm TPI	0.5 48	0.8 32	1.0 24	1.25 20	1.5 16	1.75 14	2.0 12	2.5 10	3.0 8	4.0 6	6.0 4
Number of Passes		3-6	4-7	4-9	6-10	5-11	9-12	6-13	7-15	8-17	10-20	11-22

### NOTES:

1. For most standard applications the middle of the range is a good starting point.
2. For most materials, the tougher the material, the higher the number of cutting passes you should select.
3. As a general rule of thumb, Fewer passes are better than more speed.

## Thread Turning Methods

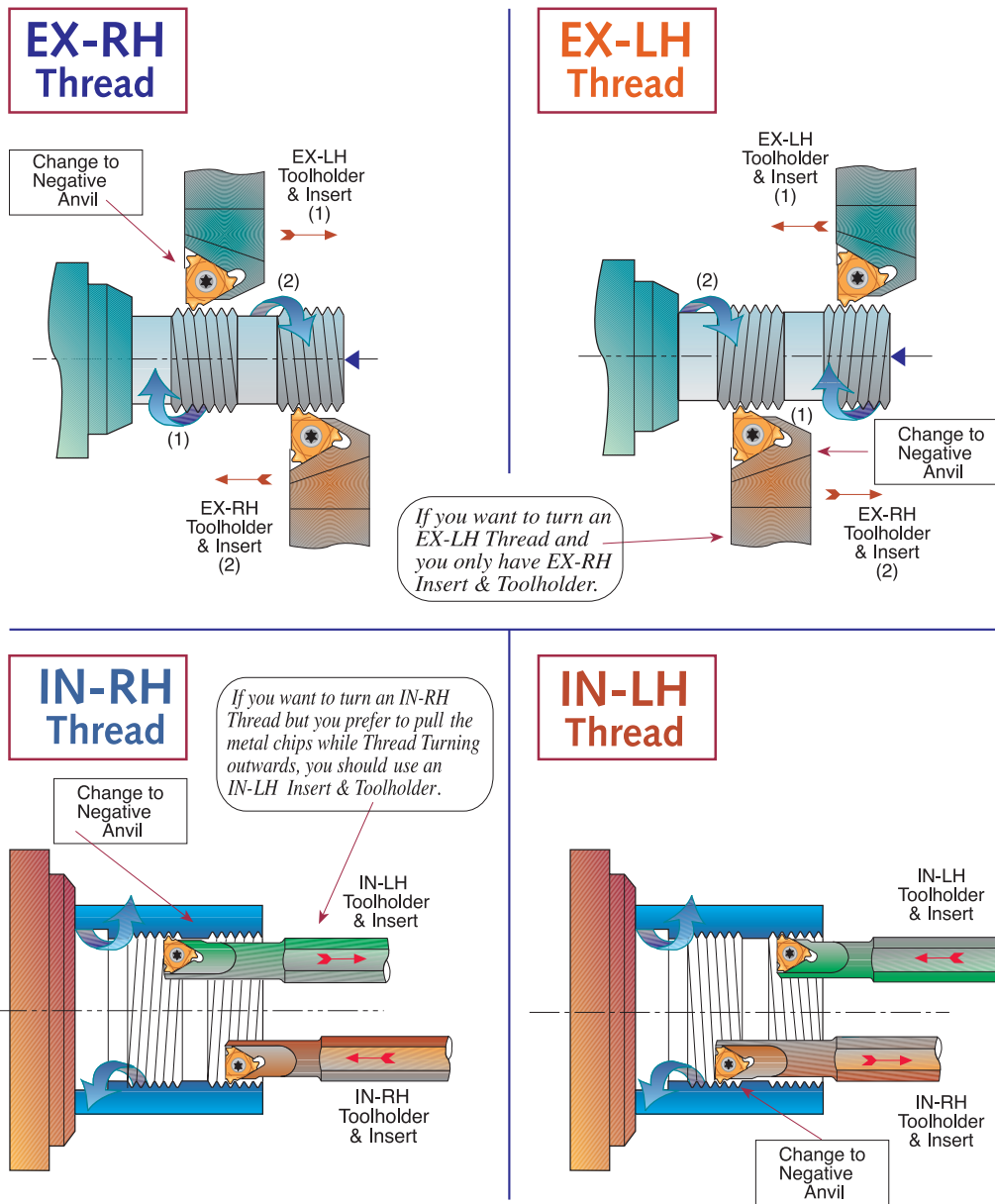

## Important Points about Carmex Threading Inserts

1. In most thread forms internal and external threads have different depth and radii, thus tools are not interchangeable

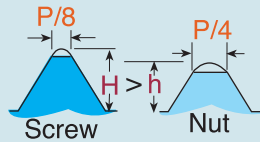

2. The Insert relief angle of a standard Carmex external toolholder is 10°; for an internal toolholder it is 15°. This 5° difference is to provide additional necessary radial clearance.

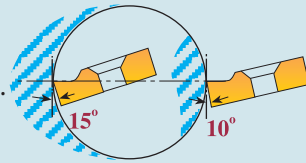

3. Our built-in relief angles ensure automatic insert flank angle clearance.

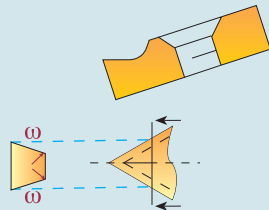

4. Profiles of Carmex internal & external threading inserts are precision ground to ensure accurate thread geometry when used in their corresponding toolholders. Using internal inserts with an external holder will result in distortion of angle and insert geometry.

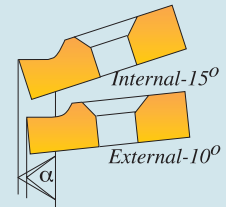

5. Insert and toolholder should always match. An IN-RH insert must be used with an IN-RH toolholder. No mismatch is allowed.



## Flank Clearance Angle $\omega$

$$\omega = \text{ArcTan} (\text{Tan } \alpha \times \text{Tan } \phi)$$

$\omega =$ 	$\omega =$ 	$\omega =$ 	$\omega =$ 	$\phi = 10^\circ$ for External toolholders
$\omega =$				$\phi = 15^\circ$ for Internal toolholders
<p>ISO, UN PARTIAL 60 NPT</p>	<p>TRAPEZ ACME STACME</p>	<p>AMERICAN BUTTRESS</p>	<p>SAGE (DIN 513)</p>	

## Anvil Change Recommendation

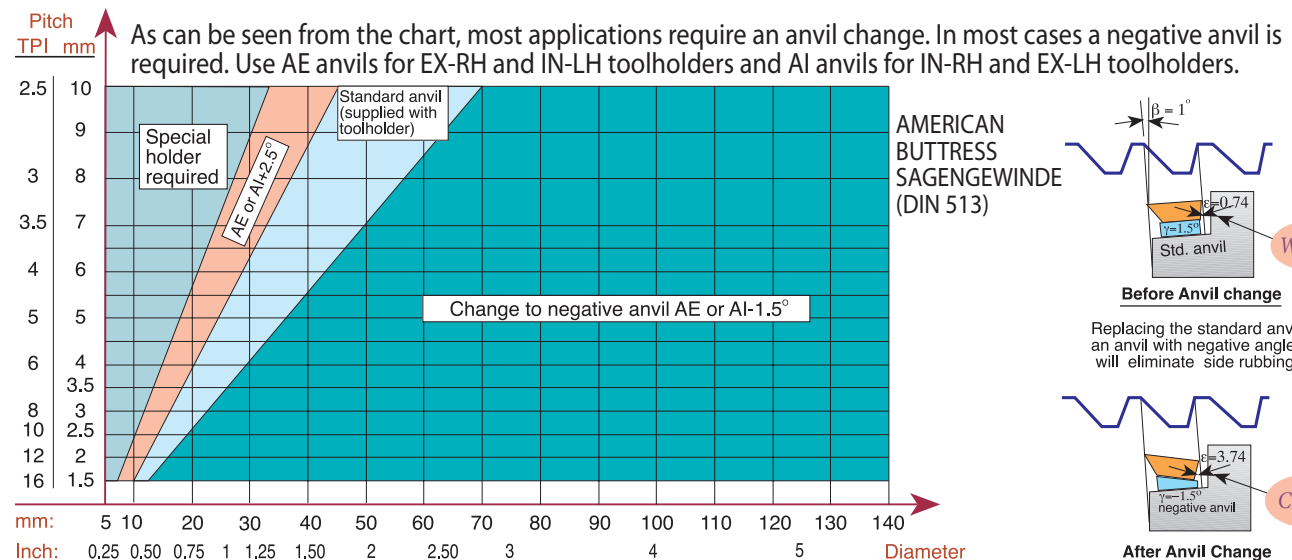
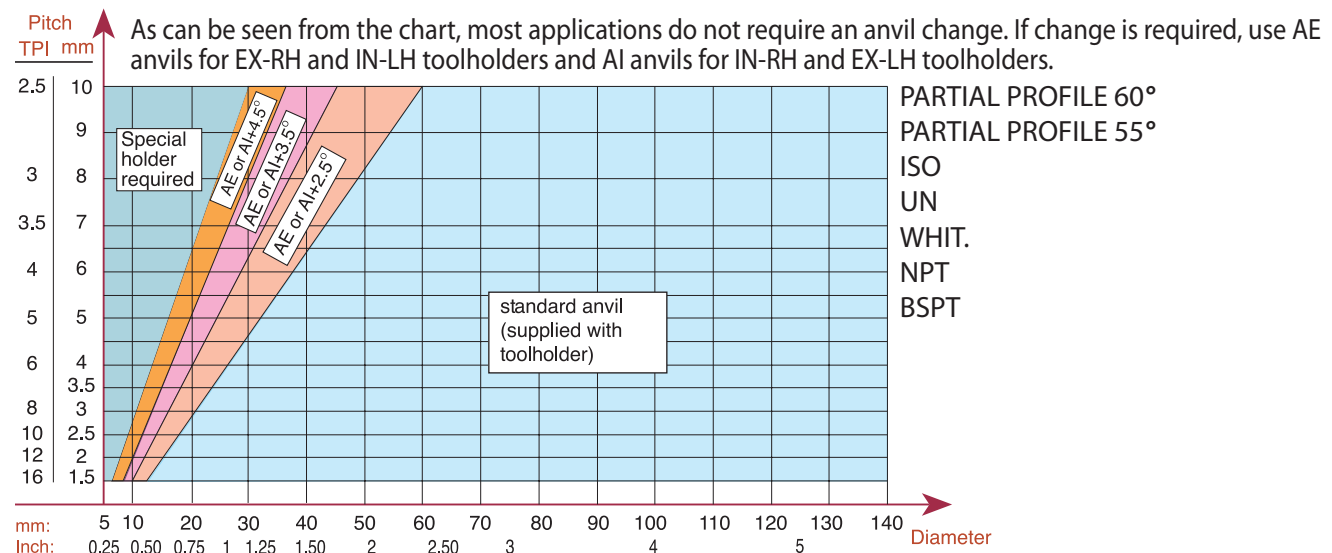
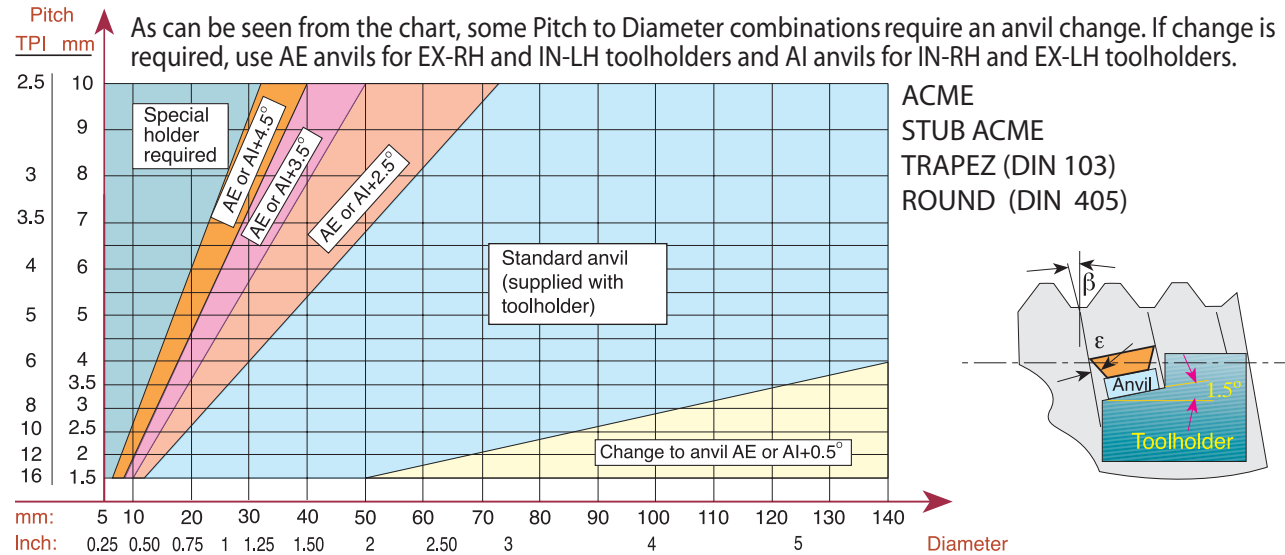

**A04-7**

## Thread Turning - Step by Step

**Step 1 : Choose Thread Turning Method**

**Step 2 : Choose Insert**

**Step 3 : Choose Toolholder**

**Step 4 : Choose Insert Grade**

**Step 5 : Choose Thread Turning Speed**

**Step 6 : Choose Number of Threading Passes**

In most cases the above mentioned 6 steps would be the steps needed to ensure a good thread. When cutting more complicated threads such as TRAPEZ, ACME, BUTTRESS or SAGE, it is advisable to check the effect of the thread "HELIX ANGLE"  $\beta$  on the "RESULTANT FLANK CLEARANCE"  $\epsilon$ . If  $\epsilon$  is smaller than  $2^\circ$ , an anvil change is required.

**Step 7 : Find Thread Helix Angle**

**Step 8 : Choose Correct Anvil**

### EXAMPLES:

#### Example No. 1:

Step 1: Choose Thread Turning Method  
from page A04-5, we chose **EX - RH Insert & Toolholder**

Step 2: Choose Insert from page A01-11: **16 ER 16 UN**

Step 3: Choose Toolholder from page A02-3: **SER 0750 K16**

Step 4: Choose Insert Grade from selection on page A04-2  
Our choice for Alloy Steel is Grade **P25C**

Step 5: Choose Thread Turning Speed from chart on page A04-3,  
we chose **330 ft/min**

Rotational Speed calculation: 
$$N = \frac{330 \times 12}{\pi \times 1.25} = 1008 \text{ rpm}$$

Step 6: Choose Number of Threading passes  
from table on page A04-5, we chose **8 passes**

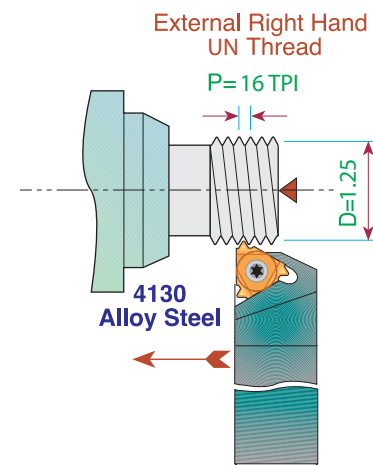

#### Example No. 2:

Step 1: Choose Thread Turning Method from page A04-5  
Usually, an IN-RH Toolholder and Insert will be chosen,  
however, in this particular case we prefer to pull the metal  
chips while thread turning outward, thus we chose to work  
with **IN-LH Insert & Toolholder**

Step 2: Choose Insert from page A01-11: **16 IL 12 UN**

Step 3: Choose Toolholder from page A02-7: **SIL 1000 R16**  
Note: since we thread cut IN-RH thread outward with an  
IN-LH tool, do not forget to replace the standard anvil  
(supplied with the holder) with a negative anvil **AE16-1.5**

Step 4: Choose Insert Grade from selection on page A04-2  
Our choice for Brass is Grade **K20**

Step 5: Choose Thread Turning Speed from chart on page A04-3,  
we chose **450 ft/min**

Rotational Speed calculation: 
$$N = \frac{450 \times 12}{\pi \times 1.5} = 1146 \text{ RPM}$$

Step 6: Choose Number of Threading passes from table  
on page A04-5, we chose **9 passes**

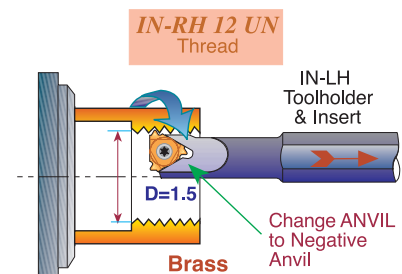



## Example No. 3:

- Step 1: Choose Thread Turning Method from page A04-5  
We chose EX-RH Insert & Toolholder.
- Step 2: Choose Insert from page A01-31: **16 ER 12 ABUT**
- Step 3: Choose Toolholder from page A02-3: **SER 1000 M16**
- Step 4: Choose Insert Grade from selection on page A04-2  
Our choice for Stainless Steel is Grade **BMA**
- Step 5: Choose Thread Turning Speed from chart on page A04-4  
We chose 360 ft/min.  
Rotational Speed calculation: 
$$N = \frac{360 \times 12}{\pi \times 1.5} = 917 \text{ RPM}$$
- Step 6: Choose Number of Threading passes from table on page A04-5. We chose **13 passes**
- Step 7: Find Thread Helix Angle: on page A02-16 for Pitch of 12 TPI and 1.5 Diameter  
Helix Angle as shown in the chart is 1°
- Step 8: Choose correct Anvil: As can be seen from the chart on page A04-7, for AMERICAN BUTTRESS Thread, for 12 TPI and 1.5 Diameter a negative anvil **AE16-1.5** should replace the standard anvil supplied with the toolholder

EX-RH. AMERICAN BUTTRESS  
12 TPI on 1.5 diameter.

Stainless Steel 304

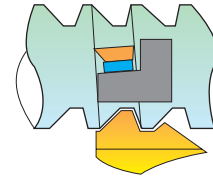

Replacing the standard anvil with an anvil with negative angle, will eliminate side rubbing

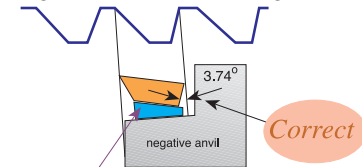

Anvil chosen:  
**AE16-1.5**

## Troubleshooting

### Chipping

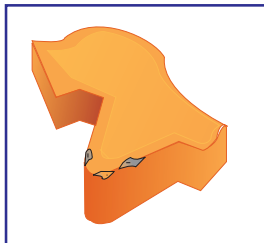

1. Use a tougher carbide grade
2. Eliminate tool overhang
3. Check if insert is correctly clamped
4. Eliminate vibration

### Crater Wear



1. Reduce cutting speed
2. Apply coolant fluid
3. Use a harder carbide grade

### Build-up Edge



1. Increase cutting speed
2. Use a tougher carbide grade

### Thermal Cracking



1. Reduce cutting speed
2. Apply coolant fluid
3. Use a tougher carbide grade

### Deformation

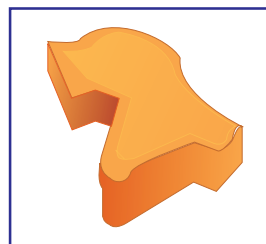

1. Use a harder carbide grade
2. Reduce cutting speed
3. Reduce depth of cut
4. Apply coolant fluid

### Fracture



1. Use a tougher carbide grade
2. Reduce depth of cut
3. Index insert sooner
4. Check machine and tool stability

## Threading Inserts Standards

Thread Profile	Standard	Thread Class
ISO	DIN 13	6g / 6H
UN	ANSI B1.1-1989	2A / 2B
WHITWORTH	B.S. 84: 1956	Medium Class
NPT	ANSI B1.20.1-1983	-
NPTF	ANSI B1.20.3-1976	-
NPS	ANSI B1.20.1-1983	-
NPSM	ANSI B1.20.1-1983	-
BSPT	B.S. 21: 1957	-
DIN 477	DIN 477	-
ACME	ANSI B1.5-1988	3G (EXT), 3G / 2G (INT)
STUB ACME	ANSI B1.8-1988	2G
TRAPEZ	DIN 103	7e / 7H
ROUND	DIN 405	Class 7
UNJ	MIL-S-8879C	3A / 3B
MJ	ISO 5855	4h/6h, 4H/5H
AMERICAN BUTTRESS	ANSI B1.9-1973	Class 2
SAGENGEWINDE	DIN 513	-
PG	DIN 40430	-
V-0.040	API Spec7	-
V-0.038R	API Spec7	-
V-0.050	API Spec7	-
V-0.055	API Spec7	-
API ROUND	API Spec Standard 5B	-
EXTREME – LINE CASING	API Spec Standard 5B	-
BUTTRESS CASING	API Spec Standard 5B	-
VAM	VAM	-
HUGHES	HUGHES	-
PAC	PAC	-

DIN: **Deutsches Institut für Normung**  
 ANSI: **American National Standards Institute**  
 API: **American Petroleum Institute**  
 B.S.: **British Standards**  
 ISO: **International Organisation for Standardization**  
 MIL-S: **Military Specification**  
 NPT: **American National Standard Taper Pipe Thread**  
 NPTF: **National Standard Taper Fuel:Dryseal USA**  
 PAC: **Pacific Asia Connection**  
 NPS: **Straight thread,same as NPT without taper**  
 NPSM: **Free-Fitting Mechanical Joints**