



Demonstration



Vertical milling indexable inserts and toolholders to perform a wide variety of threads, grooves, chamfers and more.

Advantages of CMT - Vertical Milling

- Ground profile inserts for high precision and excellent performance.
- Working at high machining parameters, with high surface quality.
- Solid and accurate clamping method enables full repeatability.
- Same insert for right-hand or left-hand threads.
- Toolholders include weldon shank and coolant bore.
- Chamfer inserts are also available.

Contents:

Page:

Contents:

Page:

Introduction: CMT Vertical Milling

Product Identification

Inserts

Partial Profile 60° - ISO, UN

Partial Profile 60° - NPT

Partial Profile 55° - BSP(G), BSF, BSW

Full Profile - ISO

Full Profile - UN

G 55° BSW, BSF, BSP

Trapez - DIN 103

Acme

Round - DIN 405

Chamfering and Grooving

Chamfering, Grooving and Boring

Dovetail 45°

Groove Milling

2

3-4

5-21

5-6

6

7

8-9

10-11

12

12

12

13

13

14

14

15

15-19

Face Milling and Finishing

Corner Rounding

Front and Back Corner Rounding

Toolholders

Steel Toolholders

Carbide Shank Toolholders

CMT Multi Insert Milling Cutters

Product Identification

Groove Milling

Chamfering

Partial Profile 60° - ISO, UN

Toolholders

Milling Cutter - Arbor

Milling Cutter - Shell Mill

Milling Cutter - Weldon Shank

Milling Cutter - Disc Milling

19

20

21

22-23

22

23

24

25

26-27

27

28

29-30

29

29

30

30

CMT Vertical Milling

Advantages

- Ground profile inserts for high precision and excellent performance.
- Working at high machining parameters, with high surface quality.
- Solid and accurate clamping method enables full repeatability.
- Same insert and holder for right-hand or left-hand threads.
- Toolholders include weldon shank and coolant bore.

CMT Straight Flute Inserts

Carbide Grade: MT7

Inserts are available in MT7 Sub-Micron Grade with Titanium Aluminum Nitride multi-layer coating (ISO K10 - K20). This is a general purpose grade, covering a very wide range of materials.

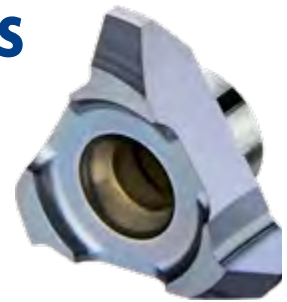

CMT Spiral Multi Flute Inserts

- Multi flute: 4-8 cutting edges
- Spiral flute for smooth cutting

The new cutters are designed for large range of materials including hardened steel up to 62 HRc.

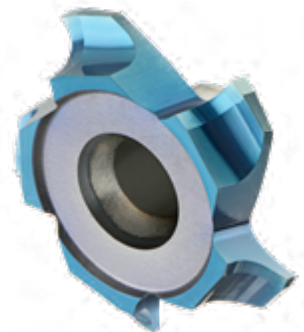

Advantages

- Longer tool life
- High material removal and higher feeds results increased productivity
- Excellent surface finish
- Reduced cycle time
- Low cutting forces due to the spiral multi flutes

Carbide Grade: MT8

Sub Micron grade with advanced PVD triple coating (ISO K10-K20). Extremely high heat resistant and smooth cutting operation, high performance, for all machining conditions.

Product Identification - Ordering Codes

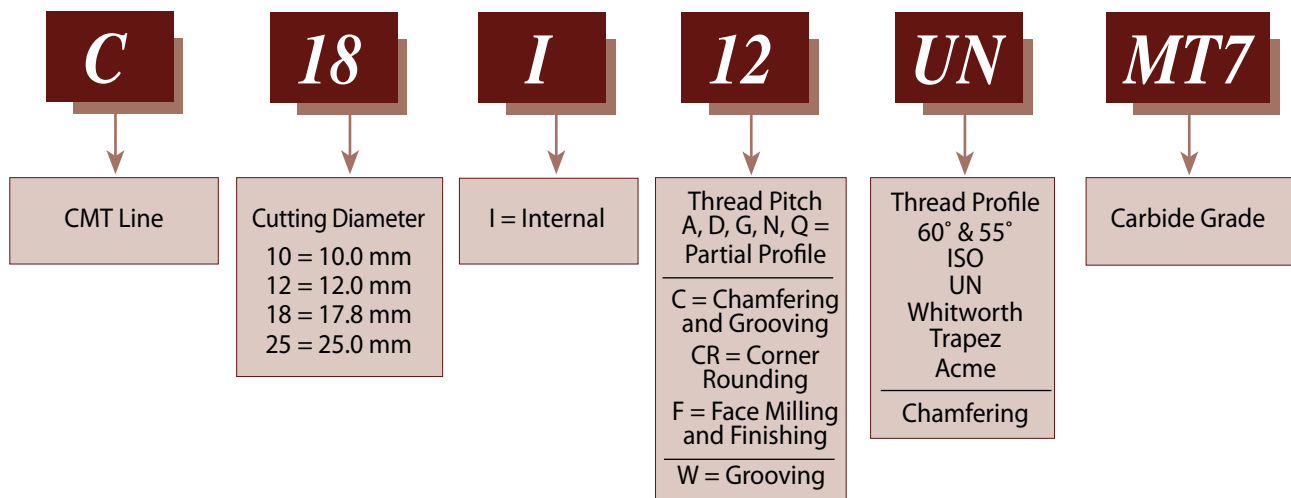
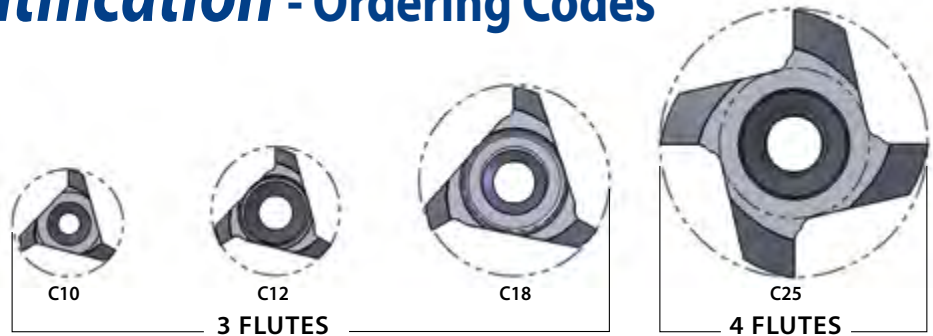

CMT Spiral Multi Flute Inserts

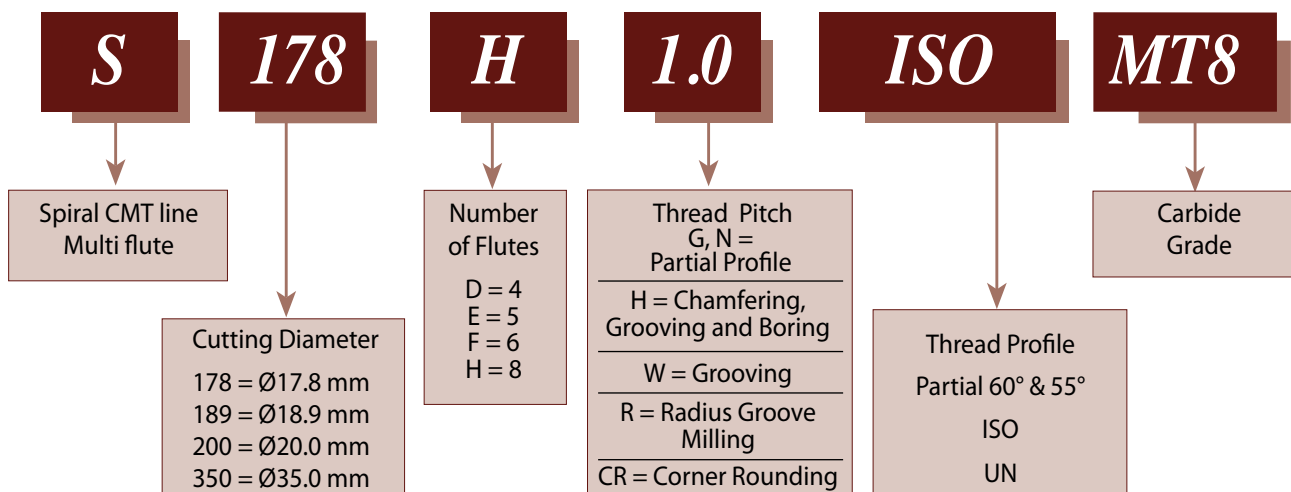

Product Identification - Ordering Codes CMT Toolholders

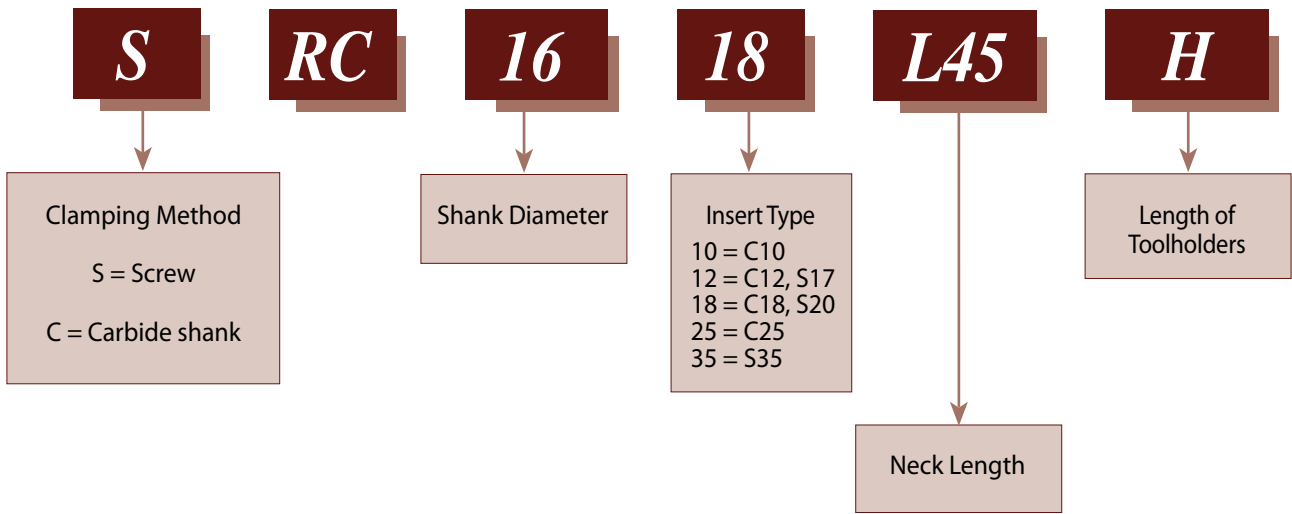

Partial Profile 60° - ISO, UN

Same insert for internal and external thread

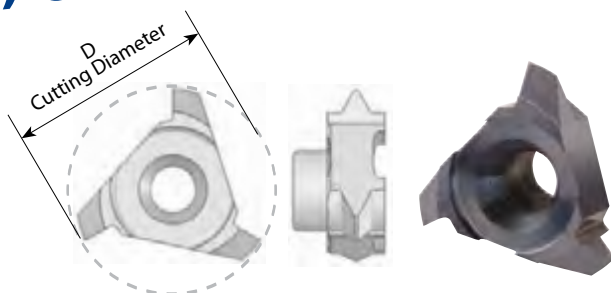

Insert Type	Ordering Code	Pitch Range mm	Pitch Range TPI	D	Thread Diameter (min)		Holder Code*
					Low Range	High Range	
C10	C10 A60	Int. 0.5 - 0.8	56 - 28	10.0	Ø ≥ 11	Ø ≥ 12	H1, 1.1, 2, 15, 16, 17
		Ex. 0.4 - 0.8	64 - 32				
	C10 G60	Int. 1.0 - 2.0	28 - 13	10.0	Ø ≥ 12	Ø ≥ 14	
		Ex. 0.8 - 1.75	32 - 15				
C12	C12 A60	Int. 0.5 - 0.8	56 - 28	12.0	Ø ≥ 13	Ø ≥ 14	H3, 3.1, 4, 5, 18, 19, 20
		Ex. 0.4 - 0.8	64 - 32				
	C12 G60	Int. 1.0 - 2.0	28 - 13	12.4	Ø ≥ 14	Ø ≥ 16	
		Ex. 0.8 - 1.75	32 - 15				
	C12 AG60	Int. 1.5 - 2.5	18 - 11	12.4	Ø ≥ 15	Ø ≥ 17	
		Ex. 1.25 - 2.0	24 - 13				
C18	C18 A60	Int. 0.5 - 0.8	56 - 28	17.8	Ø ≥ 19	Ø ≥ 19	H5.1, 5.2, 6, 7, 8, 9, 21, 22, 23
		Ex. 0.4 - 0.8	64 - 32				
	C18 G60	Int. 1.0 - 1.75	28 - 14	17.8	Ø ≥ 20	Ø ≥ 21	
		Ex. 0.8 - 1.5	32 - 16				
	C18 D60	Int. 2.0 - 3.0	13 - 8	17.8	Ø ≥ 21	Ø ≥ 23	
		Ex. 1.75 - 2.5	15 - 10				
C25	C25 G60	Int. 1.5 - 2.5	16 - 10	25.0	Ø ≥ 28	Ø ≥ 30	H10, 11, 24, 25
		Ex. 1.0 - 2.0	28 - 13				
	C25 N60	Int. 3.0 - 5.0	8 - 5	25.0	Ø ≥ 30	Ø ≥ 34	
		Ex. 2.5 - 4.5	10 - 6				
	C25 Q60	Int. 5.0 - 6.0	5 - 4	25.0	Ø ≥ 34	Ø ≥ 35	
		Ex. 4.5 - 5.0	6 - 5				

* For complete toolholder description see pages B07-22 and 23

Partial Profile 60° - ISO, UN

Same insert for internal and external thread

Multi Flute

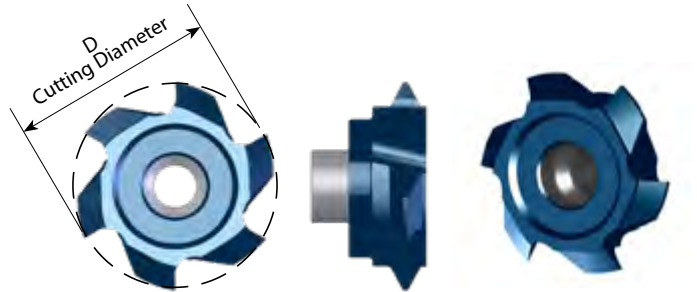

Insert Type	Ordering Code	Pitch Range mm	Pitch Range TPI	D	No. of Flutes	Thread Dia (min)		Holder Code*
						Pitch Low range	Pitch High range	
S17	S160 F AG60	Int. 1.0-3.5	28-7	16.0	6	$\varnothing \geq 20$	$\varnothing \geq 22$	H3, 3.1, 4, 5, 18, 19, 20
		Ex. 0.8-3.0	32-8.5					
S20	S200 F G60	Int. 1.5-2.5	16-10	20.0	6	$\varnothing \geq 23$	$\varnothing \geq 25$	H5.1, 5.2, 6, 7, 8, 9, 21, 22, 23
		Ex. 1.0-2.0	28-13					
S20	S200 D N60	Int. 3.0-5.0	8-5	20.0	4	$\varnothing \geq 25$	$\varnothing \geq 29$	H5.1, 5.2, 21
		Ex. 2.5-4.5	10-6					
S35	S350 F N60	Int. 3.0-5.0	8-5	35.0	6	$\varnothing \geq 38$	$\varnothing \geq 40$	H12, 13, 14, 26
		Ex. 2.5-4.5	10-6					
S35	S350 F Q60	Int. 5.0-6.0	5-4	35.0	6	$\varnothing \geq 40$	$\varnothing \geq 44$	H12, 13, 14, 26
		Ex. 4.5-5.0	6-5					

Partial Profile 60° - NPT

Same insert for internal and external thread

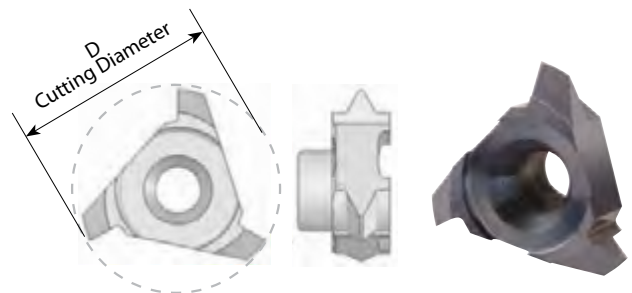

Insert Type	Ordering Code	Pitch TPI	Standard	D	Holder Code*
C10	C10 18 NPT	18	1/4 - 3/8	10.0	H1, 1.1, 2, 15, 17
C18	C18 14 NPT	14	1/2 - 3/4	15.8	H5.1, 5.2, 21
C25	C25 11.5NPT	11.5	1-2	25.0	H10, 11, 24, 25
	C25 8 NPT	8	$\geq 2 \frac{1}{2}$	25.0	

* For complete toolholder description see pages B07-22 and 23

Partial Profile 55° - BSP(G), BSF, BSW

Same insert for internal and external thread

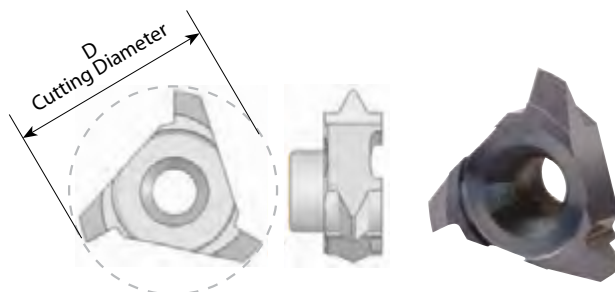

Insert Type	Ordering Code	Pitch Range TPI	D	Thread Dia. (min)	Holder Code*
C10	C10 G55	19-14	10.0	$\text{Ø} \geq 13$	H1, 2, 15, 17
C12	C12 G55	28-19	12.0	$\text{Ø} \geq 14$	H3, 3.1, 4, 5, 18, 19, 20
	C12 N55	14-11	12.2	$\text{Ø} \geq 16$	H3, 4, 5, 18, 20
C18	C18 G55	14-8	18.0	$\text{Ø} \geq 23$	H5.1, 5.2, 21
C25	C25 N55	7-5	25.0	$\text{Ø} \geq 31$	H10, 11, 24, 25

Partial Profile 55° - BSP(G), BSF, BSW

Same insert for internal and external thread

Multi Flute

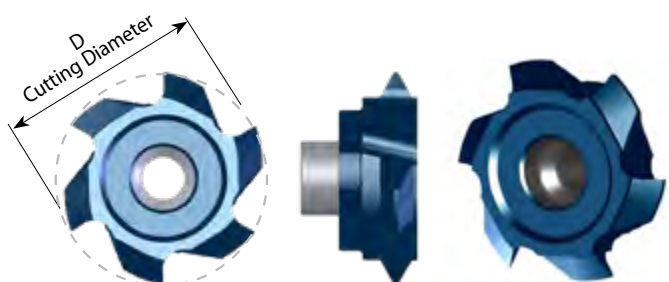

Insert Type	Ordering Code	Pitch Range TPI	D	No. of Flutes	Thread Dia (min)	Holder Code*
S17	S170 F G55	11-8	17.0	6	$\text{Ø} \geq 18.5$	H3, 3.1, 4, 5, 18, 19, 20
S20	S195 F G55	14	19.5	6	$\text{Ø} \geq 23$	H5.1, 5.2, 6, 7, 8, 9, 21, 22, 23
	S200 D N55	8-6	20.0	4	$\text{Ø} \geq 25$	

* For complete toolholder description see pages B07-22 and 23

Full Profile - ISO

Inserts for internal thread

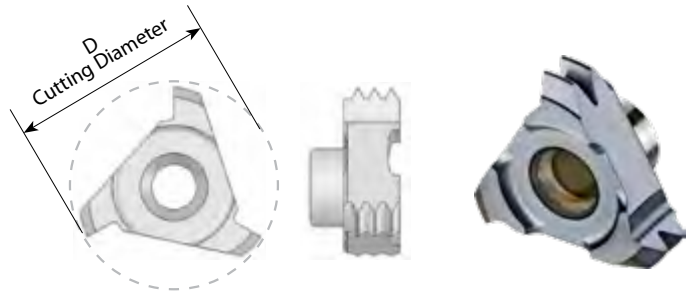

Insert Type	Ordering Code	Pitch mm	M coarse	M fine	Number of Teeth	D	Holder Code*
C10	C10 I 0.5 ISO	0.5		M10, M12	6	9.0	H1, 1.1, 2, 15, 16, 17
	C10 I 0.75 ISO	0.75		M12	4	10.0	
	C10 I 1.0 ISO	1.0		M12, M13	3	10.0	
	C10 I 1.5 ISO	1.5		M13, M14	2	10.0	
	C10 I 1.75 ISO	1.75	M12		1	9.6	H1, 2, 15, 17
	C10 I 2.0 ISO	2.0	M14	M18	1	10.0	
C12	C12 I 0.5 ISO	0.5		M13-M18	6	12.0	H3, 3.1, 4, 5, 18, 19, 20
	C12 I 0.75 ISO	0.75		M13-M18	4	12.0	
	C12 I 1.0 ISO	1.0		M14-M19	3	12.0	
	C12 I 1.5 ISO	1.5		M15-M19	2	12.0	
	C12 I 2.0 ISO	2.0	M16	M18, M20	1	12.4	H3, 4, 5, 18, 20
	C12 I 2.5 ISO	2.5	M18, M20		1	12.0	
C18	C18 I 0.5 ISO	0.5		M19-M60	9	17.8	H5.1, 5.2, 6, 7, 8, 9, 21, 22, 23
	C18 I 0.75 ISO	0.75		M19-M60	6	17.8	
	C18 I 1.0 ISO	1.0		M20-M60	5	17.8	
	C18 I 1.5 ISO	1.5		M20-M60	3	17.8	
	C18 I 2.0 ISO	2.0		M21-M60	2	17.8	
	C18 I 2.5 ISO	2.5	M22		2	17.8	
	C18 I 3.0 ISO	3.0	M24, M27	M28-M60	1	17.8	
	C18 I 3.5 ISO	3.5	M30, M33		1	17.8	
C25	C25 I 3.0 ISO	3.0	M32, M33	M30-M80	2	25.0	H10, 11, 24, 25
	C25 I 3.5 ISO	3.5	M33		1	25.0	
	C25 I 4.0 ISO	4.0	M36, M39	M48-M80	1	25.0	
	C25 I 4.5 ISO	4.5	M42, M45		1	25.0	
	C25 I 5.0 ISO	5.0	M48, M52		1	25.0	
	C25 I 5.5 ISO	5.5	M56, M60		1	25.0	
	C25 I 6.0 ISO	6.0	M64, M68	M70-M80	1	25.0	

* For complete toolholder description see pages B07-22 and 23

Full Profile - ISO

Inserts for internal thread

Multi Flute

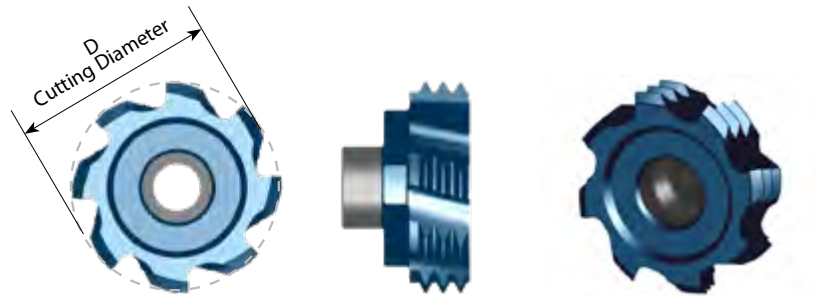

Insert Type	Ordering Code	Pitch mm	M coarse	M fine	Number of Teeth	D	No. of Flutes	Holder Code*
S17	S160 F 2.5 ISO	2.5	M20		1	16.0	6	H3, 3.1, 4, 5, 18, 19, 20
S20	S163 H 1.0 ISO	1.0		M18-M60	5	16.3	8	H5.1, 5.2, 6, 7, 8, 9, 21, 22, 23
	S175 H 1.5 ISO	1.5		M20-M60	3	17.5	8	
	S186 F 2.0 ISO	2.0		M22-M60	2	18.6	6	
	S178 F 2.5 ISO	2.5	M22		2	17.8	6	
	S189 F 3.0 ISO	3.0	M24, M27	M28-M60	1	18.9	6	
	S200 F 3.5 ISO	3.5	M30, M33		1	20.0	6	
	S200 F 4.0 ISO	4.0	M36, M39	M40-M60	1	20.0	6	
	S200 E 4.5 ISO	4.5	M42		1	20.0	5	
S35	S200 D 5.0 ISO	5.0	M48, M52		1	20.0	4	H12, 13, 14, 26
	S350 F 4.5 ISO	4.5	M45	M54	1	35.0	6	
	S350 F 6.0 ISO	6.0	M64, M68		1	35.0	6	
	S350 F 8.0 ISO	8.0		M130-M200	1	35.0	6	

* For complete toolholder description see pages B07-22 and 23

Full Profile - UN

Inserts for internal thread

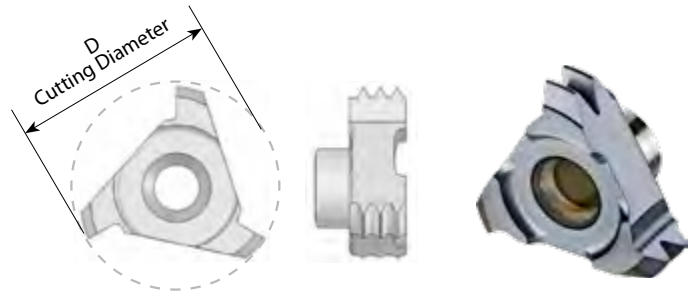

Insert Type	Ordering Code	Pitch TPI	Nominal Size	UNC	UNF	UNEF	Number of Teeth	D	Holder Code*
C10	C10 I 20 UN	20			1/2		2	10.0	H1, 1.1, 2, 15, 16, 17
	C10 I 18 UN	18			9/16		2	10.0	
	C10 I 13 UN	13		1/2			1	10.0	H1, 2, 15, 17
	C10 I 12 UN	12	5/8, 11/16, 3/4	9/16			1	10.0	
C12	C12 I 32 UN	32	9/16, 5/8				3	12.0	H3, 3.1, 4, 5, 18, 19, 20
	C12 I 28 UN	28	9/16, 5/8, 11/16				3	12.0	
	C12 I 24 UN	24				9/16, 5/8, 11/16	2	12.0	
	C12 I 20 UN	20	9/16, 5/8, 11/16			3/4	2	12.0	
	C12 I 18 UN	18			5/8		2	12.0	
	C12 I 16 UN	16	5/8, 11/16		3/4		1	12.0	
	C12 I 12 UN	12	5/8				1	12.4	
	C12 I 11 UN	11		5/8			1	12.0	H3, 4, 5, 18, 20
	C12 I 10 UN	10		3/4			1	12.0	
C18	C18 I 32 UN	32	3/4, 13/16, 7/8				6	17.8	H5.1, 5.2, 6, 7, 8, 9, 21, 22, 23
	C18 I 28 UN	28	3/4, 13/16, 7/8				5	17.8	
	C18 I 24 UN	24					4	17.8	
	C18 I 20 UN	20	11/16, 11/8			13/16, 7/8, 15/16	3	17.8	
	C18 I 18 UN	18					3	17.8	
	C18 I 16 UN	16	7/8, 1				3	17.8	
	C18 I 14 UN	14			7/8		2	17.8	
	C18 I 12 UN	12	7/8		1, 11/8		2	17.8	
	C18 I 11 UN	11					2	17.8	
	C18 I 9 UN	9		7/8			1	17.8	
C18 I 8 UN	8		1			1	17.8		
C25	C25 I 8 UN	8	13/16, 11/4, 15/16				2	25.0	H10, 11, 24, 25
	C25 I 7 UN	7		11/4			1	25.0	
	C25 I 6 UN	6	17/16, 19/16	13/8, 11/2			1	25.0	
	C25 I 5 UN	5		1 3/4			1	25.0	
	C25 I 4 UN	4		2 1/2, 2 3/4			1	25.0	

* For complete toolholder description see pages B07-22 and 23

Full Profile - UN

Inserts for internal thread

Multi Flute

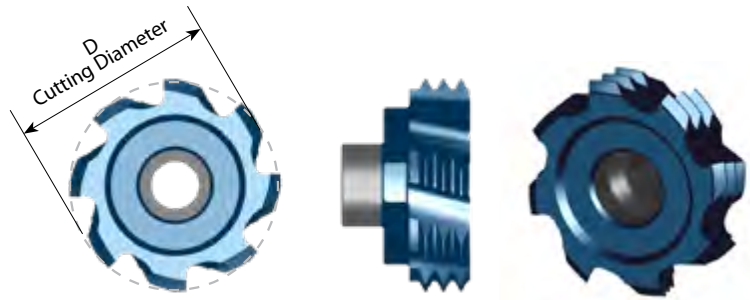

Insert Type	Ordering Code	Pitch TPI	Nominal size	UNC	UNF	UNEF	Number of Teeth	D	No. of Flutes	Holder Code*
S17	S150 F 10 UN	10		3/4			1	15.0	6	H3, 3.1, 4, 5, 18, 19, 20
	S160 H 24 UN	24				11/16	4	16.0	8	
S20	S169 H 20 UN	20				3/4, 13/16, 7/8, 15/16, 1	4	16.9	8	
	S164 F 16 UN	16	7/8, 15/16, 1		3/4		3	16.4	6	H5.1, 5.2, 6, 7, 8, 9, 21, 22, 23
	S191 F 14 UN	14			7/8		2	19.1	6	
	S186 F 12 UN	12	7/8, 15/16		1		2	18.6	6	
	S178 F 9 UN	9		7/8			1	17.8	6	
	S200 F 8 UN	8	1 1/8	1			1	20.0	6	
	S200 F 7 UN	7		1 1/8, 1 1/4			1	20.0	6	
	S200 E 6 UN	6	1 7/16	1 3/8, 1 1/2			1	20.0	5	
	S200 D 5 UN	5		1 3/4			1	20.0	4	
S350 F 8 UN	8	1 5/8, 1 3/4				2	35.0	6		
S35	S350 F 4 UN	4		2 1/2, 2 3/4, 3			1	35.0	6	H12, 13, 14, 26

* For complete toolholder description see pages B07-22 and 23

G 55° BSW, BSF, BSP

Same insert for internal and external thread

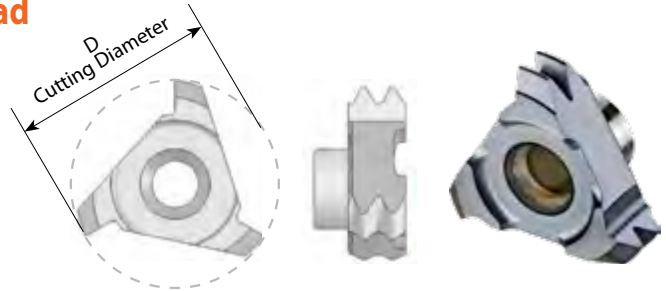

Insert Type	Ordering Code	Pitch TPI	Standard	Number of Teeth	D	Holder Code*
C10	C10 19 W	19	G 1/4	2	10.0	H1, 1.1, 2, 15, 16, 17
C12	C12 19 W	19	G 3/8	2	12.0	H3, 3.1, 4, 5, 18, 19, 20
C18	C18 14 W	14	G 1/2 - 7/8	2	17.8	H5.1, 5.2, 6, 7, 8, 9, 21, 22, 23
	C18 11 W	11	G ≥ 1	2	17.8	

Trapez - DIN 103

Inserts for internal thread

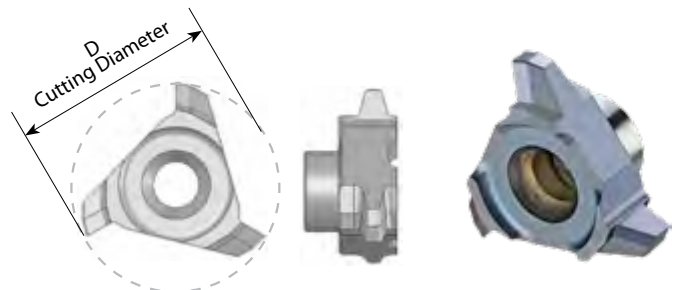

Insert Type	Ordering Code	Pitch mm	Standard	D	Holder Code*
C10	C10 I 2 TR	2.0	Tr16x2, Tr18x2	10.0	H1, 2, 15, 17
C12	C12 I 2 TR	2.0	Tr20x2	12.0	H3, 4, 5, 18, 20
C18	C18 I 3 TR	3.0	Tr24x3	17.8	H5.1, 5.2, 6, 7, 8, 9, 21, 22, 23
	C18 I 4 TR	4.0	Tr26x4	17.8	
	C18 I 5 TR	5.0	Tr28x5	17.8	
C25	C25 I 6 TR	6.0	Tr36x6	25.0	H10, 11, 24, 25

* For complete toolholder description see pages B07-22 and 23

Acme

Inserts for internal thread

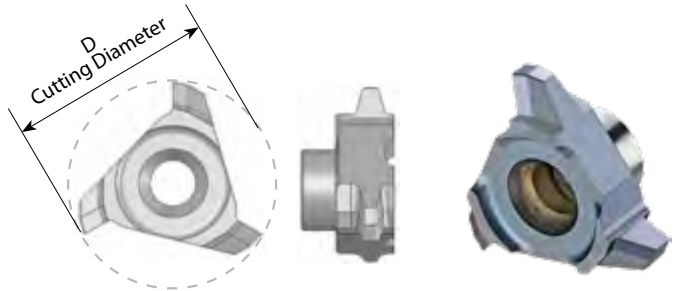

Insert Type	Ordering Code	Pitch TPI	Standard	D	Holder Code*
C18	C18 I 5 ACME	5	1 ¹ / ₈ , 1 ¹ / ₄	18.0	H5.1, 5.2, 21
C25	C25 I 4 ACME	4	1 ¹ / ₂ , 1 ³ / ₄ , 2	25.0	H10, 11, 24, 25

Round-DIN 405

Inserts for internal thread

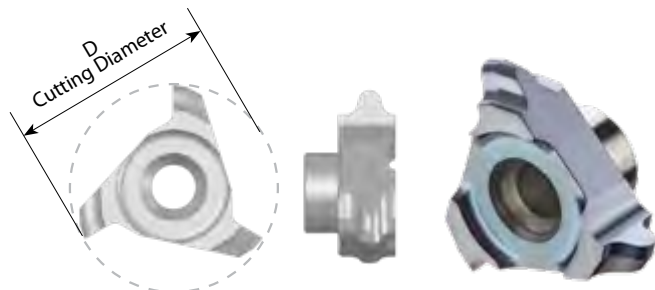

Insert Type	Ordering Code	Pitch TPI	Standard	D	Holder Code*
C18	C18 1/8RD	8	1/8RD	17.8	H5.1, 5.2, 6, 7, 8, 9, 21, 22, 23
	C18 1/6RD	6	1/6RD	17.8	H5.1, 5.2, 21
C25	C25 1/4RD	4	1/4RD	25.0	H10, 11, 24, 25

* For complete toolholder description see pages B07-22 and 23

Chamfering and Grooving

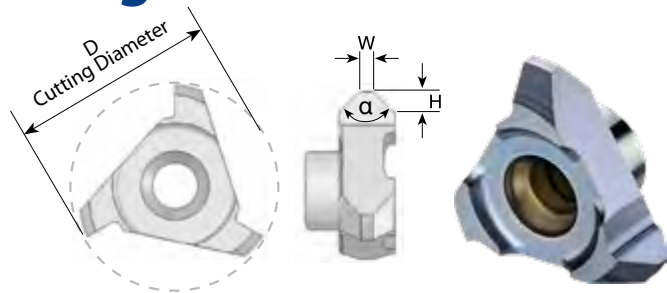

Insert Type	Ordering Code	D	H	W	α	Holder Code*
C10	C10 C90	10.0	1.30	0.4	90°	H1, 2, 15, 17
C12	C12 C90	12.0	1.35	0.3	90°	H3, 4, 5, 18, 20
C18	C18 C90	17.8	1.95	1.1	90°	H5.1, 5.2, 6, 7, 8, 9, 21, 22, 23
C25	C25 C90	25.0	2.50	1.0	90°	H10, 11, 24, 25

Chamfering, Grooving and Boring Multi Flute

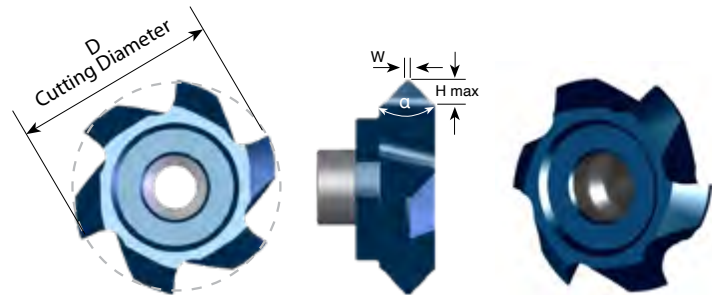

Insert Type	Ordering Code	D	H max	W	α	No. of Flutes	Holder Code*
S17	SC160 E H14	16.0	1.35	0.2	90°	5	H3, 3.1, 4, 5, 18, 19, 20
S20	SC170 E H14	17.0	1.35	0.2	90°	5	H6, 7, 8, 9, 21, 22, 23
	SC200 F H14	20.0	1.35	0.2	90°	6	H5.1, 5.2, 6, 7, 8, 9, 21, 22, 23
	SC200 F H24	20.0	2.35	0.2	90°	6	
S35	SC350 F H42	35.0	4.20	0.2	90°	6	H12, 13, 14, 26
S20	SC200 F H20	20.0	1.95	1.0	90°	6	H5.1, 5.2, 6, 7, 8, 9, 21, 22, 23
	SC200 F H17	20.0	1.70	1.5	90°	6	
	SC200 F H15	20.0	1.50	2.0	90°	6	
	SC200 F H12	20.0	1.20	2.5	90°	6	

* For complete toolholder description see pages B07-22 and 23

Dovetail 45° Multi Flute

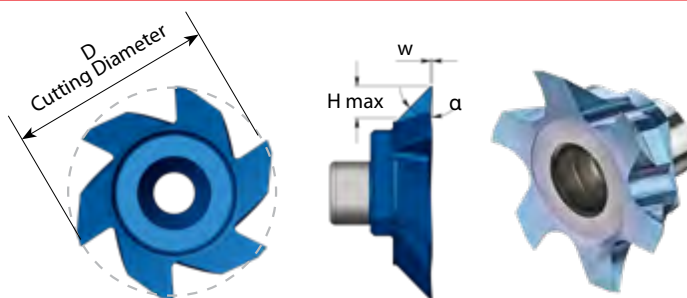

Insert Type	Ordering Code	D	H	W	α	No. of Flutes	Holder Code*
S17	SC170 F A45	17.0	2.5	0.1	45°	6	H3, 3.1, 4, 5, 18, 19, 20
S20	SC200 F A45	20.0	3.0	0.1	45°	6	H5.1, 5.2, 6, 7, 8, 9, 21, 22, 23

Groove Milling

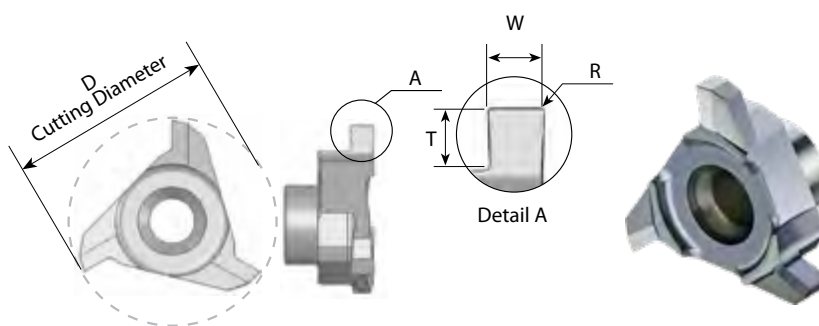

Insert Type	Ordering Code	D	W ±0.02	T max.	R	Groove Dia. (min.)	Holder Code*
C10	C10 W08	10.0	0.80	0.80	0.1	∅ > 10.0	H1, 1.1, 2, 15, 16, 17
	C10 W09	10.0	0.90	0.90	0.1	∅ > 10.0	
	C10 W10	10.0	1.00	0.90	0.1	∅ > 10.0	
	C10 W15	10.0	1.50	1.20	0.1	∅ > 10.0	H1, 2, 15, 17
	C10 W20	10.0	2.00	1.20	0.1	∅ > 10.0	
C12	C12 W08	12.0	0.80	0.80	0.1	∅ > 12.0	H3, 3.1, 4, 5, 18, 19, 20
	C12 W10	12.0	1.00	0.90	0.1	∅ > 12.0	
	C12 W10T	12.3	1.00	1.60	0.2	∅ > 12.3	
	C12 W15	12.4	1.50	1.60	0.1	∅ > 12.4	H3, 4, 5, 18, 20
	C12 W20	12.4	2.00	1.60	0.1	∅ > 12.4	
	C12 W25	12.4	2.50	1.60	0.1	∅ > 12.4	
C18	C18 W10	17.8	1.00	1.50	0.1	∅ > 17.8	H5.1, 5.2, 6, 7, 8, 9, 21, 22, 23
	C18 W12	17.8	1.20	1.50	0.1	∅ > 17.8	
	C18 W15	17.8	1.50	1.95	0.1	∅ > 17.8	
	C18 W20	17.8	2.00	2.80	0.1	∅ > 17.8	H5.1, 5.2, 21
C25	C25 W20	25.0	2.00	3.00	0.2	∅ > 25.0	H10, 11, 24, 25
	C25 W25	25.0	2.50	3.00	0.2	∅ > 25.0	
	C25 W30	25.0	3.00	3.00	0.2	∅ > 25.0	
	C25 W35	25.0	3.50	3.50	0.2	∅ > 25.0	
	C25 W40	25.0	4.00	3.50	0.2	∅ > 25.0	
	C25 W50	25.0	5.00	3.50	0.2	∅ > 25.0	

* For complete toolholder description see pages B07-22 and 23

Groove Milling

DIN 471/472

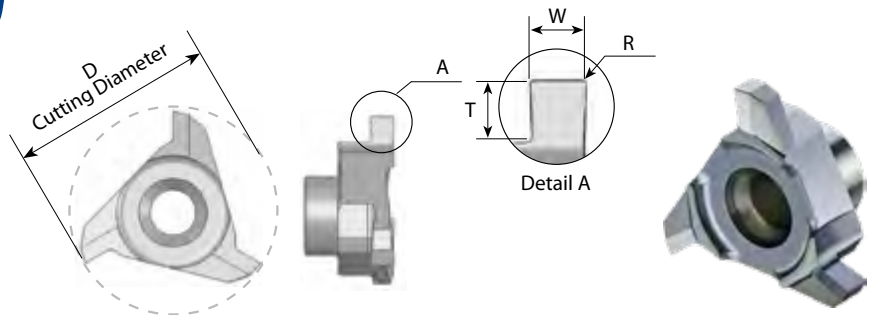

Insert Type	Ordering Code	D	Nom` groove width	W -0.04	T max.	R	Groove Dia. (min.)	Holder Code*
C10	C10 W087	10.0	0.8	0.87	1.3	0	Ø > 10.0	H1, 2, 15, 17
	C10 W097	10.0	0.9	0.97	1.3	0	Ø > 10.0	
	C10 W121	10.0	1.10	1.21	1.3	0	Ø > 10.0	
	C10 W141	10.0	1.30	1.41	1.3	0.1	Ø > 10.0	
	C10 W171	10.0	1.60	1.71	1.3	0.1	Ø > 10.0	
C12	C12 W121	12.4	1.10	1.21	1.7	0	Ø > 12.4	H3, 4, 5, 18, 20
	C12 W141	12.4	1.30	1.41	1.7	0.1	Ø > 12.4	
	C12 W171	12.4	1.60	1.71	1.7	0.1	Ø > 12.4	
C18	C18 W121	17.8	1.10	1.21	2.9	0.1	Ø > 17.8	H5.1, 5.2, 21
	C18 W141	17.8	1.30	1.41	2.9	0.1	Ø > 17.8	
	C18 W171	17.8	1.60	1.71	2.9	0.1	Ø > 17.8	
	C18 W196	17.8	1.85	1.96	2.9	0.15	Ø > 17.8	

* For complete toolholder description see pages B07-22 and 23

Groove Milling

Multi Flute

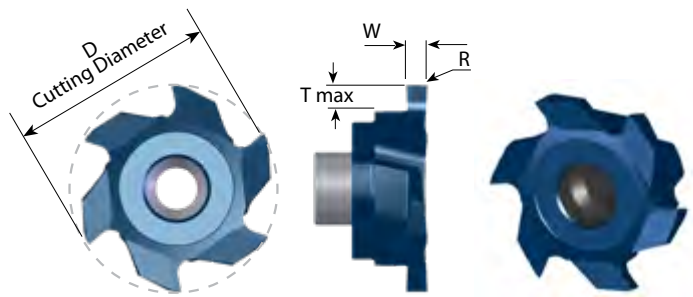

Insert Type	Ordering Code	D	W ±0.02	T Max.	R	Groove Dia. (min)	No. of Flutes	Holder Code*
S17	SG170 F W15	17.0	1.5	2.8	0.2	Ø > 17	6	H3, 3.1, 4, 5, 18, 19, 20
	SG170 F W20	17.0	2.0	2.8	0.2	Ø > 17	6	
	SG170 F W25	17.0	2.5	2.8	0.2	Ø > 17	6	
S20	SG200 F W15	20.0	1.5	2.9	0.2	Ø > 20	6	H5.1, 5.2, 6, 7, 8, 9, 21, 22, 23
	SG200 F W20	20.0	2.0	2.9	0.2	Ø > 20	6	
	SG200 F W25	20.0	2.5	2.9	0.2	Ø > 20	6	
	SG200 F W30	20.0	3.0	2.9	0.2	Ø > 20	6	
	SG200 F W40	20.0	4.0	2.9	0.2	Ø > 20	6	
	SG200 F W49	20.0	4.9	2.9	0.2	Ø > 20	6	
S20	SG200 E W20T	20.0	2.0	3.7	0.2	Ø > 20	5	H5.1, 5.2, 21
	SG200 E W25T	20.0	2.5	3.7	0.2	Ø > 20	5	
	SG200 E W30T	20.0	3.0	3.7	0.2	Ø > 20	5	
S35	SG350 F W30T	35.0	3.0	6.3	0.2	Ø > 35	6	H12, 13, 14, 26
	SG350 F W40T	35.0	4.0	6.3	0.2	Ø > 35	6	
	SG350 F W50T	35.0	5.0	6.3	0.2	Ø > 35	6	
	SG350 F W60T	35.0	6.0	6.3	0.2	Ø > 35	6	
	SG350 F W80T	35.0	8.0	6.3	0.2	Ø > 35	6	

* For complete toolholder description see pages B07-22 and 23

Groove Milling

Multi Flute

DIN 471/472

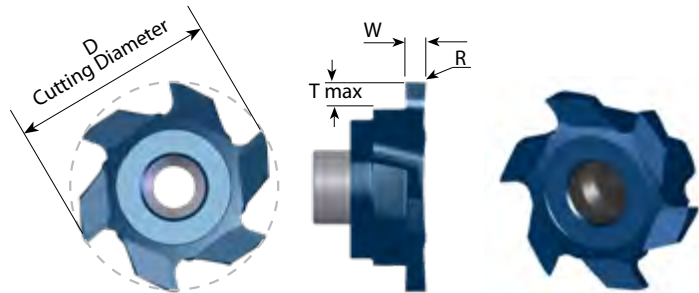

Insert Type	Ordering Code	D	Nom` groove width	W -0.04	T Max.	R	Groove Dia. (min)	No. of Flutes	Holder Code*
S20	SG200 F W121	20.0	1.10	1.21	4.0	0	Ø > 20	6	H5.1, 5.2, 21
	SG200 F W141	20.0	1.30	1.41	4.0	0.1	Ø > 20	6	
	SG200 F W171	20.0	1.60	1.71	4.0	0.1	Ø > 20	6	
	SG200 F W196	20.0	1.85	1.96	4.0	0.1	Ø > 20	6	

Full Radius Groove Milling

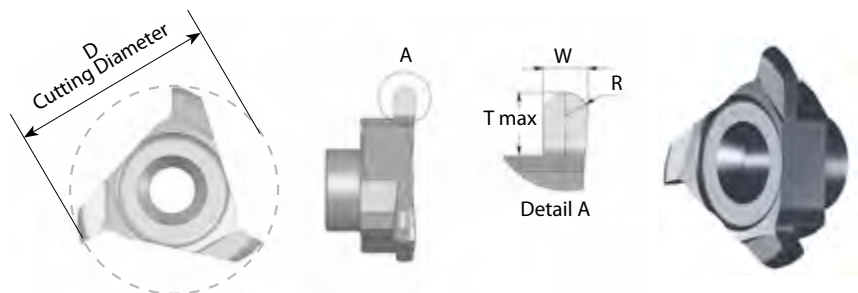

Insert Type	Ordering Code	D	R	W ±0.02	T Max.	Groove Dia. (min)	Holder Code*
C12	C12 R11	12.4	1.1	2.2	1.7	Ø > 12.4	H3, 4, 5, 18, 20
C18	C18 R08	17.8	0.8	1.6	2.9	Ø > 17.8	H5.1, 5.2, 21
	C18 R11	17.8	1.1	2.2	2.9	Ø > 17.8	

* For complete toolholder description see pages B07-22 and 23

Full Radius Groove Milling Multi Flute

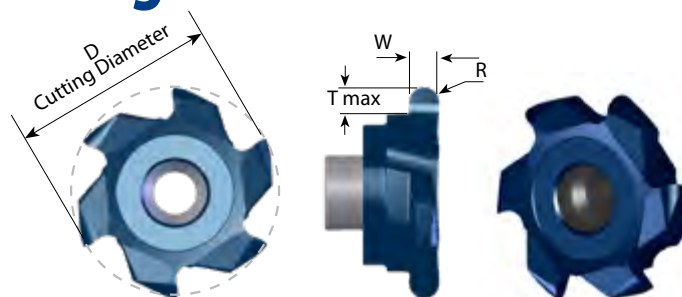

Insert Type	Ordering Code	D	R	W ±0.02	T Max.	Groove Dia. (min)	No. of Flutes	Holder Code*
S20	SG200 F R10	20.0	1.0	2.0	2.9	Ø > 20	6	H5.1, 5.2, 6, 7, 8, 9, 21, 22, 23
	SG200 F R12	20.0	1.2	2.4	2.9	Ø > 20	6	
	SG200 F R15	20.0	1.5	3.0	2.9	Ø > 20	6	
	SG200 F R20	20.0	2.0	4.0	2.9	Ø > 20	6	

Face Milling and Finishing

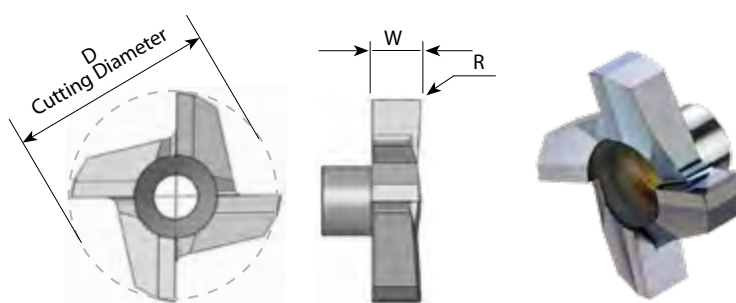

Insert Type	Ordering Code	D	W ± 0.1	R	Holder Code*
C10	C10 F R0.1	10	3.0	0.1	H1, 1.1, 2, 15, 16, 17
C12	C12 F R0.1	12	3.0	0.1	H3, 3.1, 4, 5, 18, 19, 20
C18	C18 F R0.1	17.8	5.0	0.1	H5.1, 5.2, 6, 7, 8, 9, 21, 22, 23
C25	C25 F R0.2	25.0	6.0	0.2	H10, 11, 24, 25

* For complete toolholder description see pages B07-22 and 23

Corner Rounding

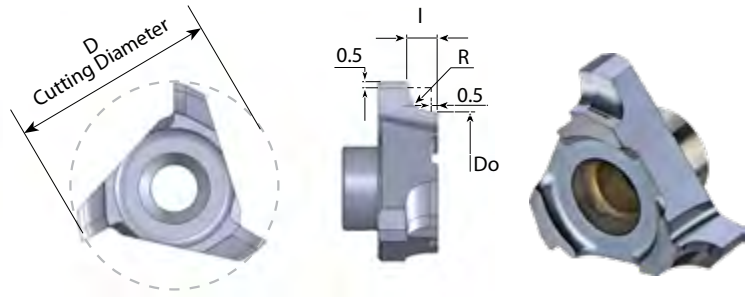

Insert Type	Ordering Code	D	Do	R	I	Holder Code*
C10	C10 CR05	10.0	7.9	0.5	1.05	H1, 1.1, 2, 15, 16, 17
	C10 CR10	10.0	6.9	1.0	1.55	
C18	C18 CR13	17.8	14.2	1.25	1.80	H5.1, 5.2, 6, 7, 8, 9, 21, 22, 23
	C18 CR15	17.8	13.7	1.5	2.05	
	C18 CR20	17.8	12.7	2.0	2.55	
C25	C25 CR30	25.0	17.7	3.0	3.60	H10, 11, 24, 25

Corner Rounding Multi Flute

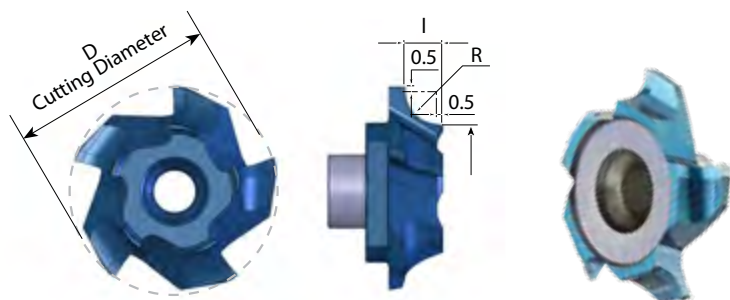

Insert Type	Ordering Code	D	Do	R	I	No. of Flutes	Holder Code*
S17	S170 E CR10	17.0	13.9	1.0	1.55	5	H3, 3.1, 4, 5, 18, 19, 20
	S170 E CR13	17.0	13.4	1.25	1.80	5	
	S170 E CR15	17.0	12.9	1.5	2.05	5	

* For complete toolholder description see pages B07-22 and 23

Front and Back Corner Rounding

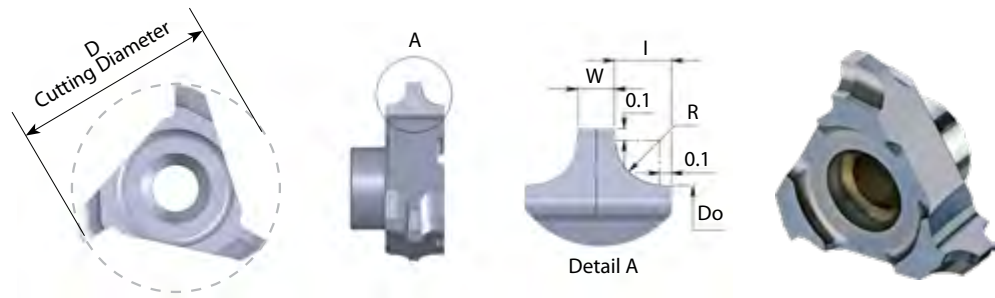

Insert Type	Ordering Code	D	Do	R	W	I	Holder Code*
C10	C10 CRD08	10.0	8.2	0.8	1.2	0.90	H1, 1.1, 2, 15, 16, 17
C18	C18 CRD15	17.8	14.6	1.5	1.8	1.60	H5.1, 5.2, 6, 7, 8, 9, 21, 22, 23
C25	C25 CRD20	25.0	20.7	2.0	2.0	2.10	H10, 11, 24, 25

Front and Back Corner Rounding Multi Flute

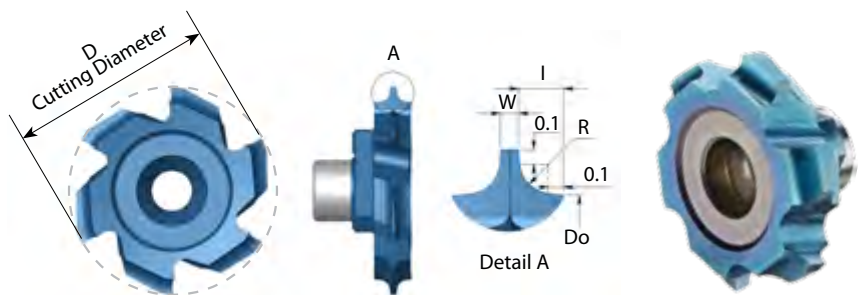

Insert Type	Ordering Code	D	Do	R	W	I	No. of Flutes	Holder Code*
S17	S170 F CRD08	17.0	15.2	0.8	1.2	0.90	6	H3, 3.3, 4, 5, 18, 19, 20
S20	S200 F CRD15	20.0	16.8	1.5	1.8	1.60	6	H5.1, 5.2, 6, 7, 8, 9, 21, 22, 23

* For complete toolholder description see pages B07-22 and 23

Steel Toolholders

With internal coolant

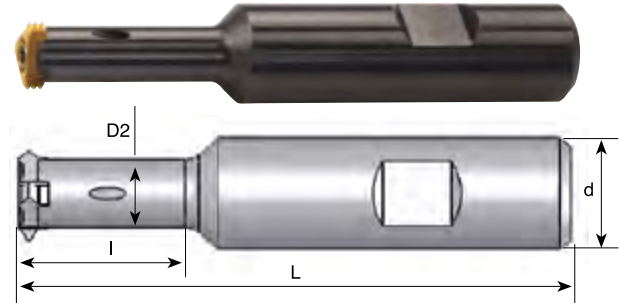

Tool No.	Ordering Code	Insert Type	d	D2	l	L	Insert Screw	Torx Key
H1	SRC 1210 E	C10	12	7.3	19	70	S5	K5
H1.1	SRC 1210 F		12	8.0	25	80	S5	K5
H2	SRC 1610 G		16	7.3	19	90	S5	K5
H3	SRC 1212 E	C12, S17	12	9.0	25	70	S10	K10
H3.1	SRC 1212 G		12	10.0	40	90	S10	K10
H4	SRC 1612 G		16	9.0	25	90	S10	K10
H5	SRC 1612 H		16	9.0	35	100	S10	K10
H5.1	SRC 1618 F	C18, S20	16	12.0	25	80	S16	K16
H5.2	SRC 1618 G		16	12.0	40	90	S16	K16
H6	SRC 1618 H		16	13.8	48	100	S16	K16
H7	SRC 2018 H		20	13.8	32	100	S16	K16
H8	SRC 2018 J		20	13.8	48	110	S16	K16
H9	SRC 2018 L		20	13.8	74	140	S16	K16
H10	SRC 2525 J	C25	25	17.5	45	115	S27	K27
H11	SRC 2525 M		25	17.5	80	150	S27	K27
H12	SRC 2035 K	S35	20	22.0	44	130	S33	K33
H13	SRC 2535 H		25	22.0	40	100	S33	K33
H14	SRC 2535 K		25	22.0	60	130	S33	K33

Carbide Shank Toolholders

With internal coolant

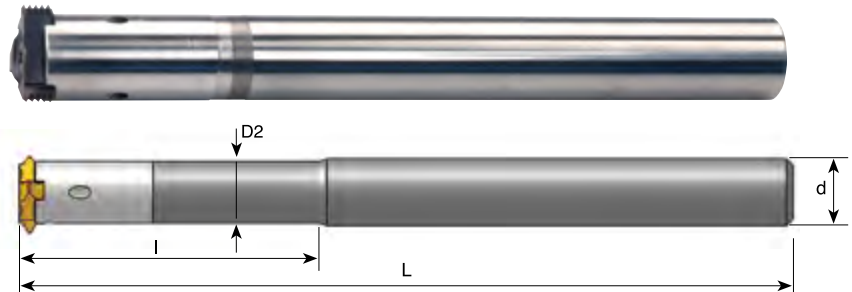

Tool No.	Ordering Code	Insert Type	d	D2	l	L	Insert Screw	Torx Key
H15	CRC 0810 L35 K	C10	8	7.3	35	125	S5	K5
H16	CRC 0810 K		8	8.0	---	125	S5	K5
H17	CRC 1010 L45 M		10	7.3	45	150	S5	K5
H18	CRC 1012 L40 M	C12, S17	10	9.0	40	150	S10	K10
H19	CRC 1012 M		10	10.0	---	150	S10	K10
H20	CRC 1212 L57 P		12	9.0	57	165	S10	K10
H21	CRC 1218 P	C18, S20	12	12.0	---	170	S16	K16
H22	CRC 1618 L48 R		16	13.8	48	195	S16	K16
H23	CRC 1618 L74 R		16	13.8	74	195	S16	K16
H24	CRC 1625 R	C25	16	17.5	28	205	S27	K27
H25	CRC 2025 L85 S		20	17.5	85	250	S27	K27
H26	CRC 2035 S		S35	20	22.0	37	260	S33

Toolholders without Weldon

CMT Multi Insert Milling Cutters

CMT indexable milling inserts and cutters for
Grooving, Chamfering and Threading



Inserts

- Insert profiles are fully ground
- Spiral inserts for smooth cutting operation
- Three cutting edges on each insert
- For a wide range of materials and applications

Carbide grade: MT7

Milling cutters / Disc milling cutter

- 4 - 8 inserts per holder, for high productivity
- For use with Carmex standard CMT S35 toolholders
- The milling cutters are coated with a special layer (silver color) for high anti-corrosive resistance and extra protection against cutting burrs



Demonstration

Product Identification - Ordering Codes

Inserts

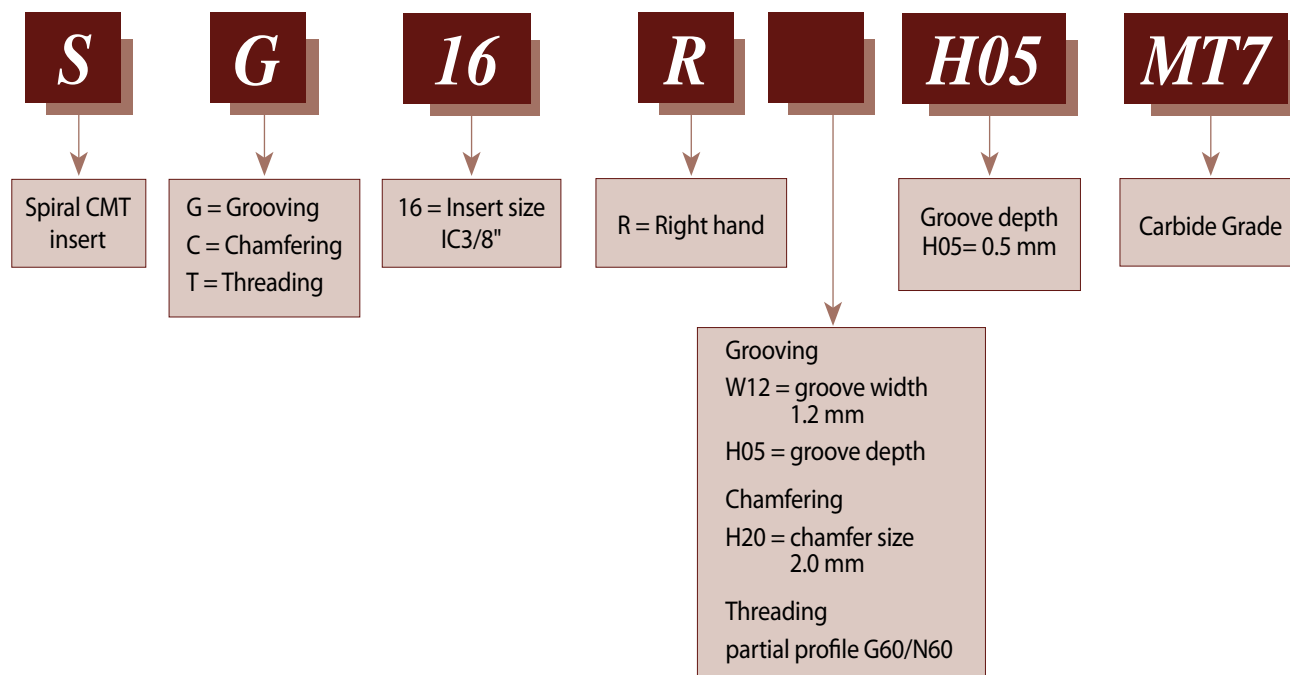

Toolholders

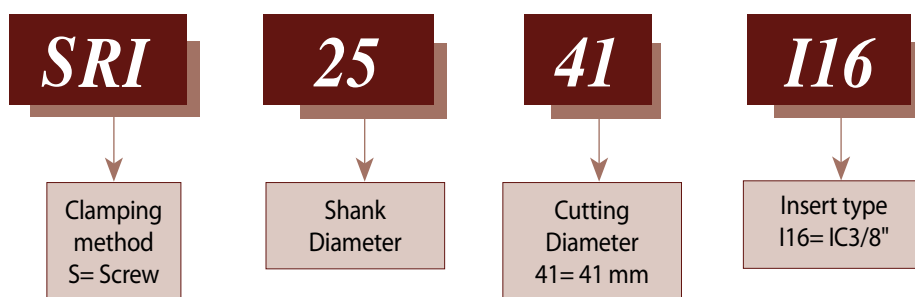

Groove Milling

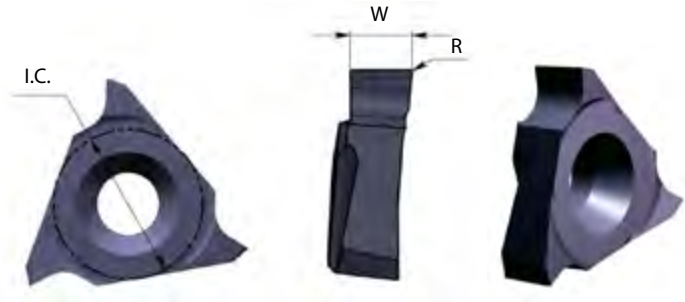

DIN 471 / 472

Insert Type	I.C.	Ordering Code	W	R	Holder Code*
SI16	3/8"	SG 16 R W14	1.40	0.10	H27, 28, 29
		SG 16 R W17	1.70	0.10	
		SG 16 R W19	1.95	0.15	
		SG 16 R W22	2.25	0.15	
		SG 16 R W27	2.75	0.20	
		SG 16 R W32	3.25	0.20	
		SG 16 R W42	4.25	0.20	H27, 29, 30
		SG 16 R W43	4.35	0.20	

Right hand cutting

Insert Type	I.C.	Ordering Code	W	R	Holder Code*
SI16	3/8"	SG 16 L W43	4.35	0.20	H30

Left hand cutting

*Maximum groove depth (T max) according to the toolholder.

* For complete toolholder description see pages B07-29 and 30

Groove Milling with Chamfer

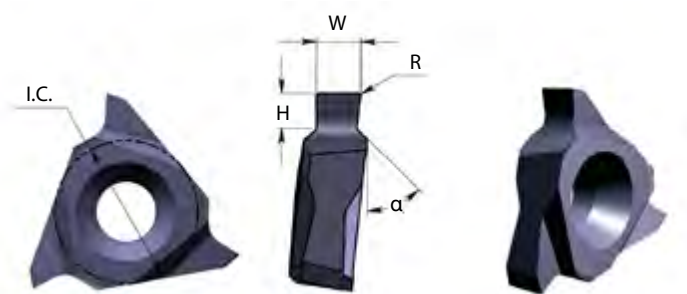

DIN 471 / 472

Insert Type	I.C.	Ordering Code	W	H max	R	α	Holder Code*
SI16	3/8"	SG 16 R W12 H05	1.20	0.50	0.10	45°	H27, 28, 29
		SG 16 R W14 H07	1.40	0.70			
		SG 16 R W14 H08	1.40	0.85			
		SG 16 R W17 H08	1.70	0.85			
		SG 16 R W17 H10	1.70	1.00			
		SG 16 R W19 H12	1.95	1.25	0.15		
		SG 16 R W22 H15	2.25	1.50			
		SG 16 R W27 H15	2.75	1.50			
		SG 16 R W27 H17	2.75	1.75			
		SG 16 R W32 H17	3.25	1.75			
		SG 16 R W42 H20	4.25	2.00			
SG 16 R W42 H25	4.25	2.50					

Right hand cutting

Chamfering

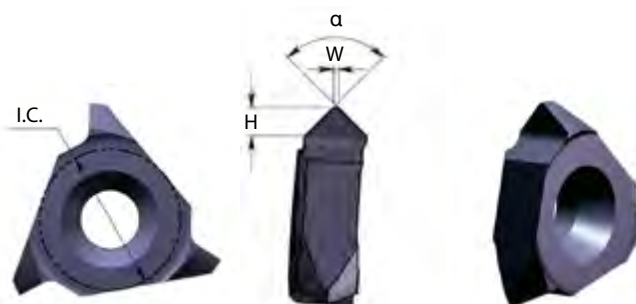

Insert Type	I.C.	Ordering Code	H max	W	α	Holder Code*
SI16	3/8"	SC 16 R H20	2.00	0.2	90°	H27, 28, 29
		SC 16 R H19	1.90	0.5		

Right hand cutting

* For complete toolholder description see pages B07-29 and 30

Partial Profile 60° - ISO, UN

Same insert for internal and external thread



Insert Type	I.C.	Ordering Code	Pitch Range mm	Pitch Range TPI	Holder Code*
SI16	3/8"	ST 16 R G60	Int. 1.5-3.0	Int. 16-8	H27, 28, 29
			Ex. 1.25-3.0	Ex. 20-8	
		ST 16 R N60	Int. 3.5-5.0	Int. 7-5	
			Ex. 3.0-4.5	Ex. 8-6	

Right hand cutting

* For complete toolholder description see pages B07-29 and 30

Toolholders

Milling Cutter - Arbor

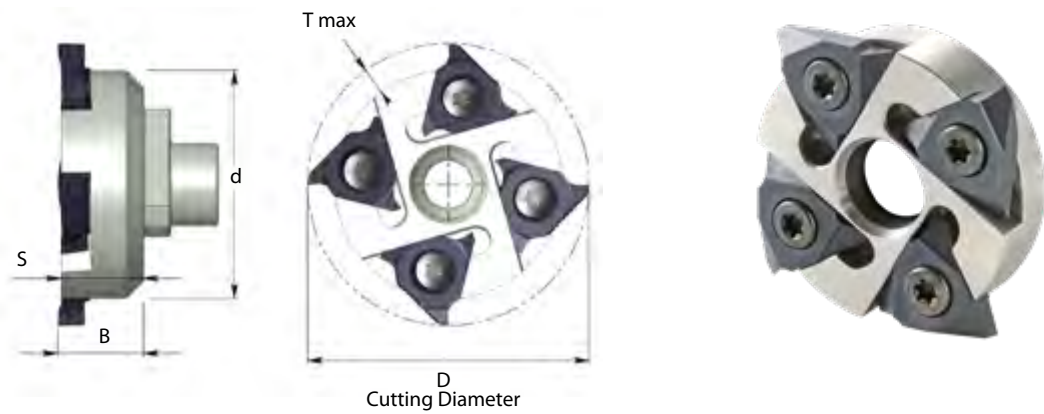

Tool No.	Ordering Code	Insert Type	D	d	T max	B	S	Insert Screw	Torx Key
H27	SRI 41- I16	SI16	41	33.2	3.6	12.5	12.0	S16S	K16

Right hand cutting

To connect to the standard CMT toolholders S35: SRC 2035 K, SRC 2535 H, SRC 2535 K, CRC 2035 S

Milling Cutter - Shell Mill

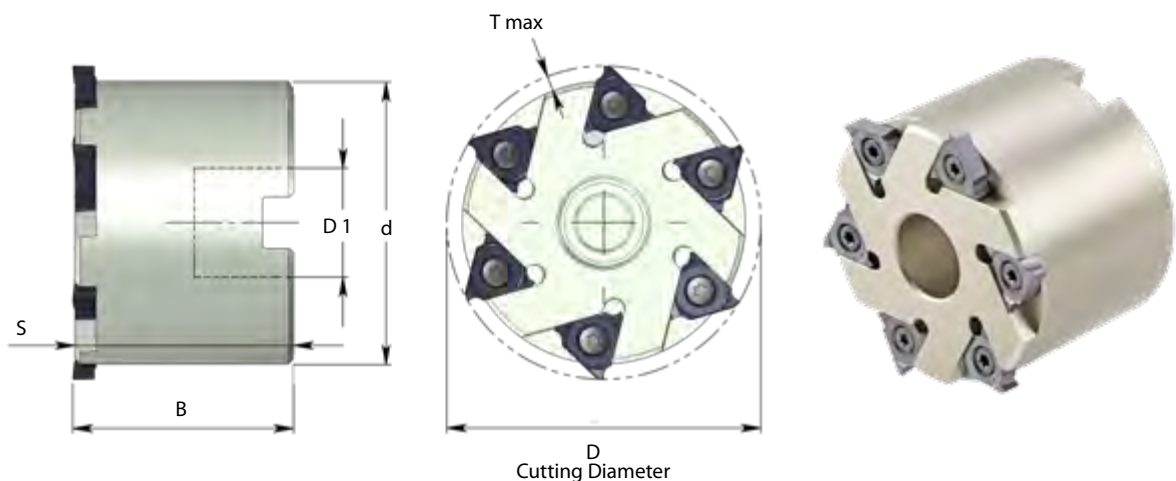

Tool No.	Ordering Code	Insert Type	D	d	T max	B	S	D1	Insert Screw	Torx Key
H28	SRI 0063-I16	SI16	63	57	3.0	44.5	44.0	22	S16S	K16

Right hand cutting

Milling Cutter - Weldon Shank

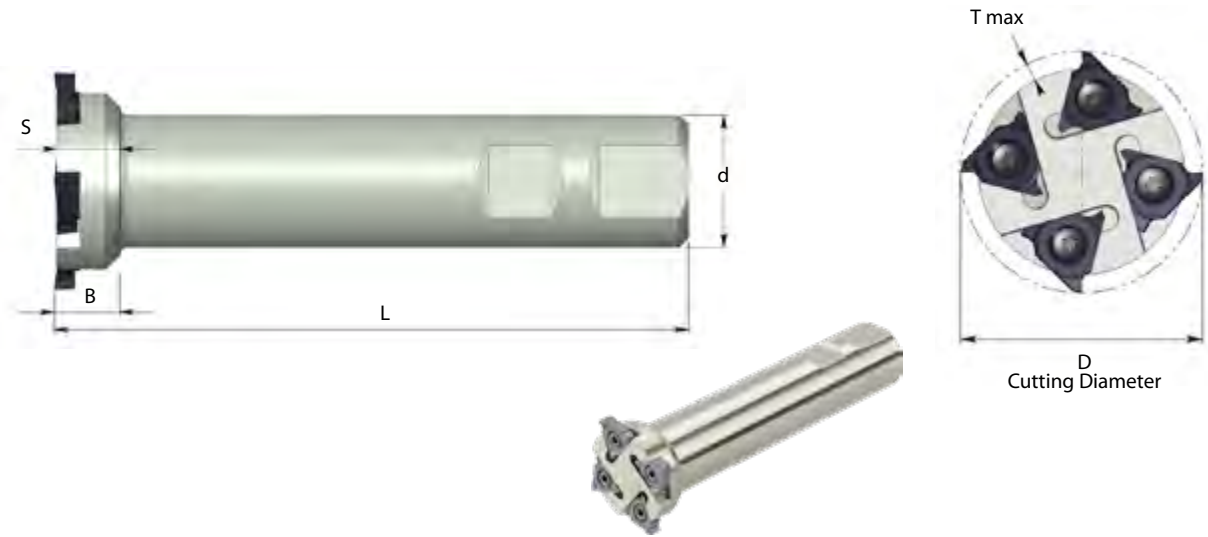

Tool No.	Ordering Code	Insert Type	D	d	T max	B	S	L	Insert Screw	Torx Key
H29	SRI 2541-I16	SI16	41	25	3.6	12.5	12.0	125	S16S	K16

Right hand cutting

Milling Cutter - Disc Milling

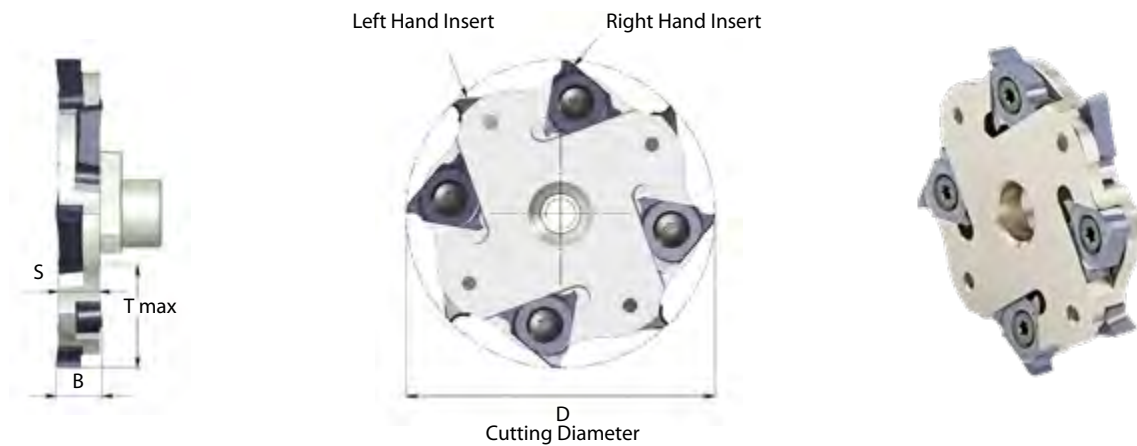

Tool No.	Ordering Code	Insert Type	D	T max	B	S	Insert Screw	Torx Key
H30	SRI 55-I16	SI16	55	15.5	8.2	7.2	S16M	K16

Right hand cutting

To use only with inserts SG 16 R W43, and SG 16 L W43

To connect to the standard CMT toolholders S35: SRC 2035 K, SRC 2535 H, SRC 2535 K, CRC 2035 S