



**Thread Turning
Catalog and CNC
Programming
Software**

Contents:	Page:	Contents:	Page:
Carbide Grade Selection	2	Thread Turning Methods	5
Type B inserts	2	Important Points about Carmex Threading Inserts	6
Recommended cutting speed	3	Flank Clearance Angle	6
Conversion of Cutting Speed to Rotational Speed	4	Anvil Change Recommendation	7
Number of passes and depth of cut per pass for multitooth insert	4	Thread Turning - Step by Step	8-9
Number of threading passes selection for single point inserts	5	Troubleshooting	9
		Threading Inserts Standards	10

Carbide Grade Selection

Choose the Carmex grade specifically formulated for your application from the following list:

Coated Grades

HBA (H10-H25) (S10-S25)	Extra-fine sub-micron grade with high toughness, for optimized performance on hardened steels and cast iron up to 62HRC, titanium alloys and super alloys (hastelloy, inconel and nickel based alloys).
BLU (M10-M20) (K05-K20) (N10-N20) (S10-S20)	PVD triple layer coated sub-micron grade for stainless steels, cast iron, titanium, non ferrous metals and most of the high temperature alloys.
BMA (P20-P40) (K20-K30)	PVD TiAlN coated sub-micrograin grade for stainless steels and exotic materials at medium to high cutting speeds.
P25C (P15-P35)	PVD TiN coated grade for treated and hard alloy steels (25 HRc & up) at medium to low cutting speeds.
MXC (K10-K20) (P10-P25)	PVD TiN coated micrograin for free cutting untreated alloy steels (below 30 HRc), for stainless steels and cast iron.
BXC (P30-P50) (K25-K40)	PVD TiN coated grade for low cutting speed. Works well with wide range of stainless steels.

Uncoated Grades

P30* (P20-P30)	Carbide grade for carbon and cast steels, works well at medium to low cutting speeds.
K20* (K10-K30)	Carbide grade for non ferrous metals, aluminum and cast iron.

* Upon request

Note: Due to our unique and specialized production techniques, Carmex coated inserts provide superior cutting performance and exceptionally long tool life.

Grade availability per inserts size

Grade	HBA	BLU	BMA	P25C	MXC	BXC	P30	K20
Insert sizes	11, 16, 22, 27	11, 16, 22	06, 08, 11, 16, 22, 27, 33U,	11, 16, 22, 27, 33U	11, 16, 22, 27, 33U	06, 08	11, 16, 22, 27, 33U	06, 08, 11, 16, 22, 27, 33U
		Type-B 11, 16	Type-B 11, 16					

Type B - Threading Inserts

A combination of ground profile, and sintered chip-breaker threading inserts. Unlike most other manufacturers inserts, this combination ensures a consistent high quality thread, with precise shape and dimensions. Two different unique styles of chip-breaker were designed to suit the different specific requirements of Internal threads and External threads. All of Carmex Type B inserts are made of BMA Sub-Micrograin grade.



Recommended cutting speed (m/min) for thread turning inserts

ISO Standard	Material		Condition							
				HBA	BLU	BMA	P25C	MXC	BXC	K20
P	Non-Alloy Steel and Cast Steel, Free Cutting Steel	<0.25%C	Annealed	110-210	120-180	100-180	100-180	70-150	50-130	
		≥0.25%C	Annealed							
		<0.55%C	Quenched & Tempered							
		≥0.55%C	Annealed							
	Low Alloy Steel and Cast Steel (less than 5% alloying elements)	Annealed		90-140	80-130	70-120	70-120	60-90	50-80	
		Quenched & Tempered								
High Alloy Steel, Cast Steel, and Tool Steel	Annealed		70-90	60-80	50-60	55-70	50-60	40-50		
	Quenched & Tempered									
M	Stainless Steel and Cast Steel		Ferritic / Martensitic	110-160	90-130	60-90	60-90	50-80	50-80	
			Martensitic							
			Austenitic							
K	Cast Iron Nodular (GGG)		Ferritic / Pearlitic	120-150	100-130		80-110	60-90		
			Pearlitic							
	Grey Cast Iron (GG)		Ferritic	140-150	120-130		90-100	65-85		
			Pearlitic							
Malleable Cast Iron		Ferritic	110-140	100-130		80-100	60-85			
		Pearlitic								
N	Aluminum-Wrought Alloy		Not Cureable	250-500			200-400	150-400	200-400	100-400
			Cured							
	Aluminum-Cast, Alloyed	<=12% Si	Not Cureable	280-500			200-500	150-350	200-500	110-300
		>12% Si	High Temperature							
	Copper Alloys	>1% Pb	Free Cutting	190-350			150-250	110-180	150-250	90-150
		Electrolytic Copper								
Non Metallic		Duroplastics, Fiber Plastics					200-300	150-210	100-200	110-150
		Hard Rubber								
S	High Temp. Alloys, Super Alloys	Fe based	Annealed	20-80	30-65	25-60				
			Cured							
		Ni or Co based	Annealed							
			Cured							
	Titanium Alloys		Alpha +Beta Alloys Cured	30-60	40-50	35-45			35-45	
H	Hardened Steel		Hardened 45-50 HRc	30-60	40-50	35-45				
			Hardened 51-55 HRc							
			Hardened 56-62 HRc							
	Chilled Cast Iron		Cast	20-50	30-40	25-35				
Cast Iron		Hardened	20-40	20-30	15-25					

Conversion of Cutting Speed to Rotational Speed

Conversion of a selected cutting speed to rotational speed is calculated by the following formula:

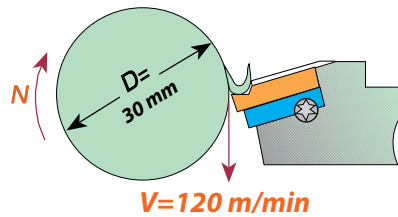

Example

$$N = \frac{V \times 1000}{\pi \times D} = \frac{120 \times 1000}{3.14 \times 30} = 1274 \text{ RPM}$$

Number of passes and depth of cut per pass for multitooth insert

	Pitch mm	Insert Size		No. of Teeth	Ordering Code	No. of Passes	Depth of Cut per pass			
		L	I.C. (in)				1	2	3	4
ISO External	1.00	16	3/8	3	16 ER 1.0 ISO 3M	2	0.38	0.25		
	1.50	16	3/8	2	16 ER 1.5 ISO 2M	3	0.42	0.30	0.20	
	1.50	22	1/2	3	22 ER 1.5 ISO 3M	2	0.55	0.37		
	2.00	22	1/2	2	22 ER 2.0 ISO 2M	3	0.57	0.40	0.28	
	2.00	22	1/2	3	22 ER 2.0 ISO 3M	2	0.76	0.49		
ISO Internal	3.00	27	5/8	2	27 ER 3.0 ISO 2M	4	0.59	0.51	0.42	0.32
	1.00	16	3/8	3	16 IR 1.0 ISO 3M	2	0.33	0.25		
	1.50	16	3/8	2	16 IR 1.5 ISO 2M	3	0.38	0.29	0.20	
	1.50	22	1/2	3	22 IR 1.5 ISO 3M	2	0.50	0.37		
	2.00	22	1/2	2	22 IR 2.0 ISO 2M	3	0.52	0.37	0.26	
UN External	2.00	22	1/2	3	22 IR 2.0 ISO 3M	2	0.70	0.45		
	3.00	27	5/8	2	27 IR 3.0 ISO 2M	4	0.58	0.46	0.39	0.30
	16	16	3/8	2	16 ER 16 UN 2M	3	0.44	0.31	0.22	
	16	22	1/2	3	22 ER 16 UN 3M	2	0.58	0.39		
	12	22	1/2	2	22 ER 12 UN 2M	3	0.59	0.42	0.30	
UN Internal	12	22	1/2	3	22 ER 12 UN 3M	2	0.78	0.52		
	8	27	5/8	2	27 ER 8 UN 2M	4	0.62	0.54	0.45	0.35
	16	16	3/8	2	16 IR 16 UN 2M	3	0.42	0.28	0.22	
	16	22	1/2	3	22 IR 16 UN 3M	2	0.55	0.37		
	12	22	1/2	2	22 IR 12 UN 2M	3	0.53	0.38	0.31	
Whitworth 55° External	12	22	1/2	3	22 IR 12 UN 3M	2	0.74	0.48		
	8	27	5/8	2	27 IR 8 UN 2M	4	0.63	0.50	0.40	0.30
	14	16	3/8	2	16 ER 14 W 2M	3	0.52	0.37	0.27	
	14	22	1/2	3	22 ER 14 W 3M	2	0.70	0.46		
	11	22	1/2	2	22 ER 11 W 2M	3	0.67	0.47	0.34	
Whitworth 55° Internal	14	16	3/8	2	16 IR 14 W 2M	3	0.52	0.37	0.27	
	14	22	1/2	3	22 IR 14 W 3M	2	0.70	0.46		
	11	22	1/2	2	22 IR 11 W 2M	2	0.67	0.47	0.34	
NPT External	14	16	3/8	2	16 ER 14 NPT 2M	3				
	11.5	22	1/2	2	22 ER 11.5 NPT 2M	4	0.54	0.47	0.37	0.30
	11.5	27	5/8	3	27 ER 11.5 NPT 3M	4	0.76	0.54	0.38	
	8	27	5/8	2	27 ER 8 NPT 2M	4	0.81	0.60	0.55	0.45
NPT Internal	14	16	3/8	2	16 IR 14 NPT 2M	3				
	11.5	22	1/2	2	22 IR 11.5 NPT 2M	4	0.54	0.47	0.37	0.30
	11.5	27	5/8	3	27 IR 11.5 NPT 3M	4	0.76	0.54	0.38	
	8	27	5/8	2	27 IR 8 NPT 2M	4	0.81	0.60	0.55	0.45
API Round External	10	22	1/2	2	22 ER 10 APIRD 2M	3	0.60	0.50	0.31	
	10	27	5/8	3	27 ER 10 APIRD 3M	2	1.00	0.41		
	8	27	5/8	2	27 ER 8 APIRD 2M	3	0.80	0.60	0.41	
API Round Internal	10	22	1/2	2	22 IR 10 APIRD 2M	3	0.60	0.50	0.31	
	10	27	5/8	3	27 IR 10 APIRD 3M	2	1.00	0.41		
	8	27	5/8	2	27 IR 8 APIRD 2M	3	0.80	0.60	0.41	

Number of threading passes selection for single point inserts

Pitch:	mm TPI	0.5 48	0.8 32	1.0 24	1.25 20	1.5 16	1.75 14	2.0 12	2.5 10	3.0 8	4.0 6	6.0 4
Number of Passes		3-6	4-7	4-9	6-10	5-11	9-12	6-13	7-15	8-17	10-20	11-22

NOTES:

1. For most standard applications the middle of the range is a good starting point.
2. For most materials, the tougher the material, the higher the number of cutting passes you should select.
3. As a general rule of thumb, fewer passes are better than more speed.

Thread Turning Methods

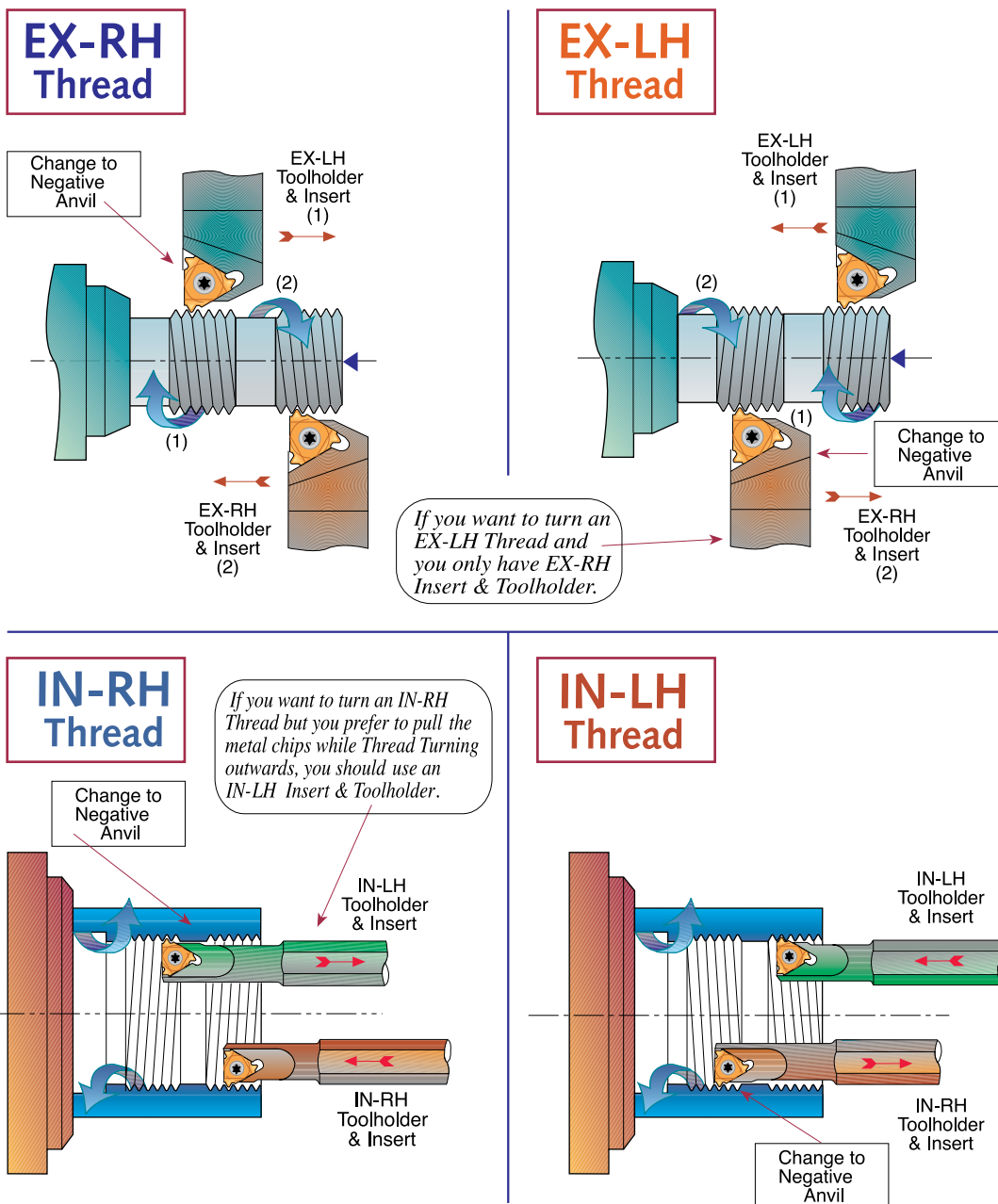

Important Points about Carmex Threading Inserts

1. In most thread forms internal and external threads have different depth and radii, thus tools are not interchangeable

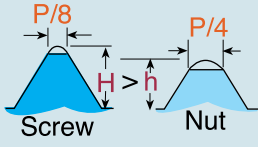

2. The Insert relief angle of a standard Carmex external toolholder is 10°; for an internal toolholder it is 15°. This 5° difference is to provide additional necessary radial clearance.

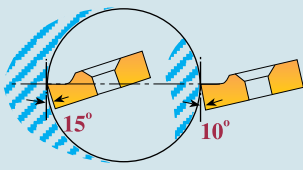

3. Our built-in relief angles ensure automatic insert flank angle clearance.

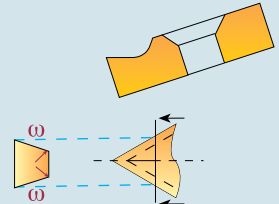

4. Profiles of Carmex internal & external threading inserts are precision ground to ensure accurate thread geometry when used in their corresponding toolholders. Using internal inserts with an external holder will result in distortion of angle and insert geometry.

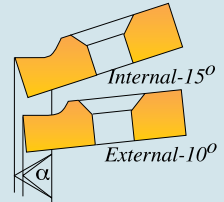

5. Insert and toolholder should always match. An IN-RH insert must be used with an IN-RH toolholder. No mismatch is allowed.



Flank Clearance Angle ω

$$\omega = \text{ArcTan} (\text{Tan } \alpha \times \text{Tan } \phi)$$

$\phi = 10^\circ$ for External toolholders

$\phi = 15^\circ$ for Internal toolholders

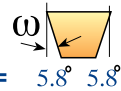
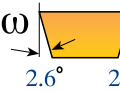
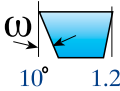
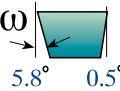
$\omega = 5.8^\circ \quad 5.8^\circ$ 	$\omega = 2.6^\circ \quad 2.6^\circ$ 	$\omega = 10^\circ \quad 1.24^\circ$ 	$\omega = 5.8^\circ \quad 0.5^\circ$ 
<p>ISO, UN PARTIAL 60 NPT</p>	<p>TRAPEZ ACME STACME</p>	<p>AMERICAN BUTTRESS</p>	<p>SAGE (DIN 513)</p>

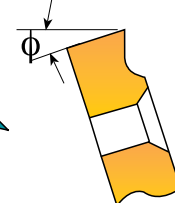

Anvil Change Recommendation

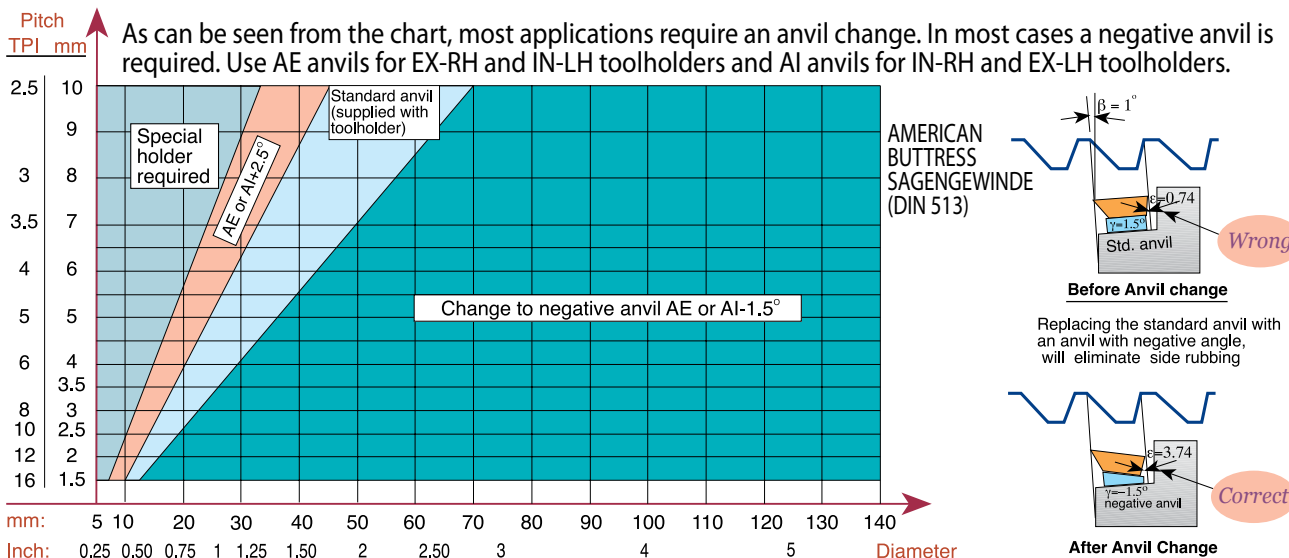
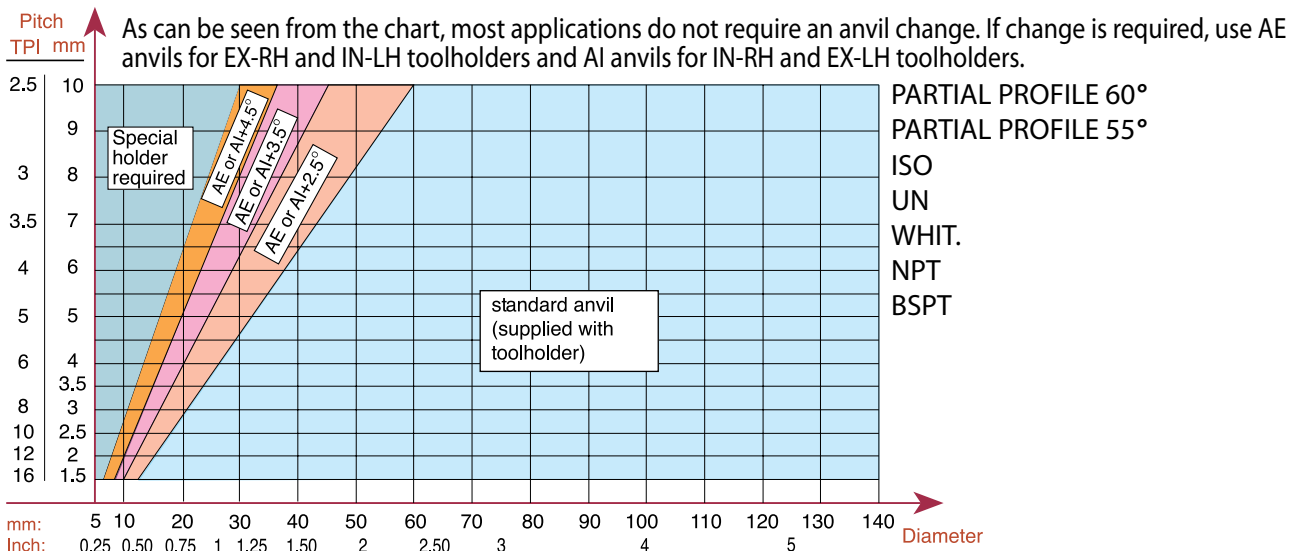
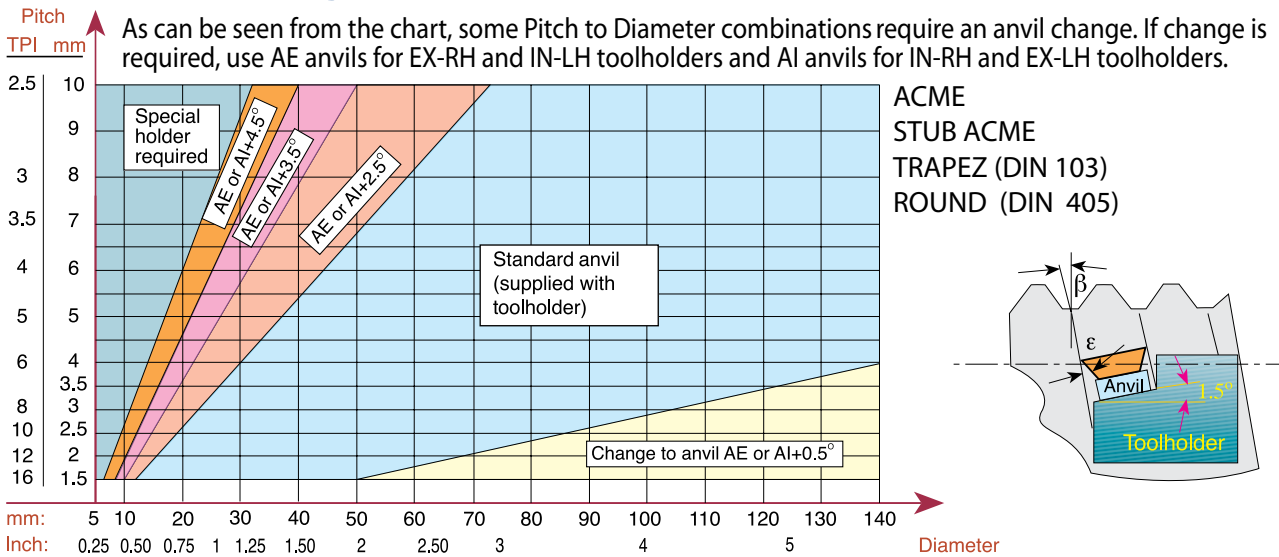

Thread Turning - Step by Step

Step 1 : Choose Thread Turning Method from page A04-5

Step 2 : Choose Insert

Step 3 : Choose Toolholder

Step 4 : Choose Insert Grade

Step 5 : Choose Thread Turning Speed

Step 6 : Choose Number of Threading Passes

In most cases the above mentioned 6 steps would be the steps needed to ensure a good thread. When cutting more complicated threads such as TRAPEZ, ACME, BUTTRESS or SAGE, it is advisable to check the effect of the thread "HELIX ANGLE" β on the "RESULTANT FLANK CLEARANCE" ϵ . If ϵ is smaller than 2° , an anvil change is required.

Step 7 : Find Thread Helix Angle

Step 8 : Choose Correct Anvil

EXAMPLES:

Example No. 1:

Step 1: Choose Thread Turning Method from page A04-5, we chose **EX - RH Insert & Toolholder**

Step 2: Choose Insert from page A01-7: **16 ER 1.5 ISO**

Step 3: Choose Toolholder from page A02-3: **SER 2020 K16**

Step 4: Choose Insert Grade from selection on page A04-2
Our choice for Alloy Steel is Grade **P25C**

Step 5: Choose Thread Turning Speed from chart on page A04-3, we chose **100 m/min**

Rotational Speed calculation:
$$N = \frac{100 \times 1000}{\pi \times 30} = 1065 \text{ rpm}$$

Step 6: Choose Number of Threading passes from table on page A04-5, we chose **8 passes**

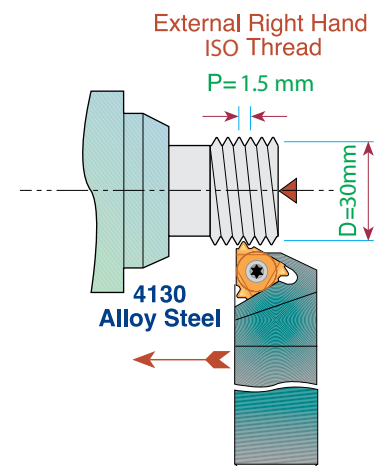

Example No. 2:

Step 1: Choose Thread Turning Method from page A04-5
Usually, an IN-RH Toolholder and Insert will be chosen, however, in this particular case we prefer to pull the metal chips while thread turning outward, thus we chose to work with **IN-LH Insert & Toolholder**

Step 2: Choose Insert from page A01-11: **16 IL 12 UN**

Step 3: Choose Toolholder from page A02-8: **SIL 0025 R16**
Note: since we thread cut IN-RH thread outward with an IN-LH tool, do not forget to replace the standard anvil (supplied with the holder) with a negative anvil **AE16-1.5**

Step 4: Choose Insert Grade from selection on page A04-2
Our choice for Brass is Grade **K20**

Step 5: Choose Thread Turning Speed from chart on page A04-3, we chose **150 m/min**

Rotational Speed calculation:
$$N = \frac{150 \times 1000}{\pi \times 38.1} = 1254 \text{ RPM}$$

Step 6: Choose Number of Threading passes from table on page A04-5, we chose **9 passes**

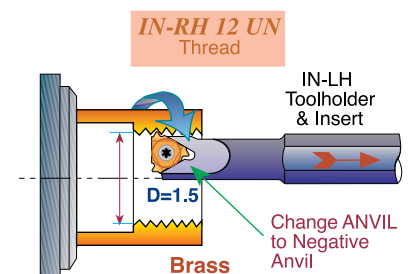

Example No. 3:

- Step 1: Choose Thread Turning Method from page A04-5
We chose EX-RH Insert & Toolholder.
- Step 2: Choose Insert from page A01-31: **16 ER 12 ABUT**
- Step 3: Choose Toolholder from page A02-3: **SER 2525 M16**
- Step 4: Choose Insert Grade from selection on page A04-2
Our choice for Stainless Steel is Grade **BMA**
- Step 5: Choose Thread Turning Speed from chart on page A04-3
We chose 120 m/min.
Rotational Speed calculation:
$$N = \frac{120 \times 1000}{\pi \times 40} = 954 \text{ RPM}$$
- Step 6: Choose Number of Threading passes from table on page A04-5. We chose **13 passes**
- Step 7: Find Thread Helix Angle: on page A02-19 for Pitch of 12 TPI and 40 Diameter Helix Angle as shown in the chart is 1°
- Step 8: Choose correct Anvil: As can be seen from the chart on page A04-7, for AMERICAN BUTTRESS Thread, for 12 TPI and 40 Diameter a negative anvil **AE16-1.5** should replace the standard anvil supplied with the toolholder

EX-RH. AMERICAN BUTTRESS
12 TPI on 40 mm diameter.

Stainless Steel 304

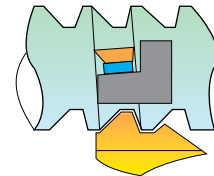

Replacing the standard anvil with an anvil with negative angle will eliminate side rubbing

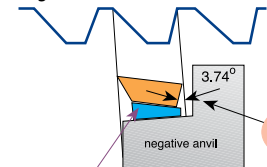

Anvil chosen:
AE16-1.5

Troubleshooting

Chipping



1. Use a tougher carbide grade
2. Eliminate tool overhang
3. Check if insert is correctly clamped
4. Eliminate vibration

Crater Wear



1. Reduce cutting speed
2. Apply coolant fluid
3. Use a harder carbide grade

Build-up Edge



1. Increase cutting speed
2. Use a tougher carbide grade

Thermal Cracking



1. Reduce cutting speed
2. Apply coolant fluid
3. Use a tougher carbide grade

Deformation



1. Use a harder carbide grade
2. Reduce cutting speed
3. Reduce depth of cut
4. Apply coolant fluid

Fracture



1. Use a tougher carbide grade
2. Reduce depth of cut
3. Index insert sooner
4. Check machine and tool stability

Threading Inserts Standards

Thread Profile	Standard	Thread Class
ISO	DIN 13	6g / 6H
UN	ANSI B1.1-1989	2A / 2B
WHITWORTH	B.S. 84: 1956	Medium Class
NPT	ANSI B1.20.1-1983	-
NPTF	ANSI B1.20.3-1976	-
NPS	ANSI B1.20.1-1983	-
NPSM	ANSI B1.20.1-1983	-
BSPT	B.S. 21: 1957	-
DIN 477	DIN 477	-
ACME	ANSI B1.5-1988	3G (EXT), 3G / 2G (INT)
STUB ACME	ANSI B1.5-1988	2G
TRAPEZ	DIN 103	7e / 7H
ROUND	DIN 405	Class 7
UNJ	MIL-S-8879C	3A / 3B
MJ	ISO 5855	4h/6h, 4H/5H
AMERICAN BUTTRESS	ANSI B1.9-1973	Class 2
SAGENGWINDE	DIN 513	-
PG	DIN 40430	-
V-0.040	API Spec7	-
V-0.038R	API Spec7	-
V-0.050	API Spec7	-
V-0.055	API Spec7	-
API ROUND	API Spec Standard 5B	-
EXTREME – LINE CASING	API Spec Standard 5B	-
BUTTRESS CASING	API Spec Standard 5B	-
VAM	VAM	-
HUGHES	HUGHES	-
PAC	PAC	-

DIN: **Deutsches Institut für Normung**
 ANSI: **American National Standards Institute**
 API: **American Petroleum Institute**
 B.S.: **British Standards**
 ISO: **International Organisation for Standardization**
 MIL-S: **Military Specification**
 NPT: **American National Standard Taper Pipe Thread**
 NPTF: **National Standard Taper Fuel:Dryseal USA**
 PAC: **Pacific Asia Connection**
 NPS: **Straight thread,same as NPT without taper**
 NPSM: **Free-Fitting Mechanical Joints**