



Type B  
Demonstration

Contents:	Page:	Contents:	Page:
Product Identification	2	VAM	34
Partial Profile 60°	3-4	HUGHES	35
Partial Profile 55°	5-6	PAC	35
ISO - metric	7-9	NPS	36
UN - Unified	10-13	NPSM	36
Whitworth - 55°	14-17	Vertical API	37
NPT	18-19	Vertical API Buttress Casing	38
NPTF	20	Vertical API Round	39
BSPT	21-22	Chasers API Round	40
DIN 477	22	Chasers API Buttress Casing	41
Acme	23	Chasers OTTM Buttress Casing	41
Stub Acme	24	Chasers API Buttress Casing	42
Trapez - DIN 103	25	Chasers OTTM Buttress Casing	42
PG - DIN 40430	26	Chasers API Buttress Casing	43
Sagengewinde - DIN 513	26	Chasers OTTM Buttress Casing	43
Round - DIN 405	27	Chasers API Buttress Casing	44
Round - DIN 20400	27	Chasers OTTM Buttress Casing	44
UNJ	28-29	<b>Large Profile Inserts and Toolholders</b>	45-50
MJ - ISO 5855	30	Large Profile Inserts Trapez - DIN 103	45
American Buttress	31	External Holders	46
<b>Threading Tools for the Oil &amp; Gas Industries</b>	32-44	Internal Holders	47
API Round	32	Large Profile Sagengewinde Inserts DIN 513	48
V-0.040	33	External Holders	49
V-0.038R	33	Internal Holders	50
V-0.050	33		
V-0.055	33		
Extreme - Line Casing	34		
Buttress Casing	34		

## Product Identification

### Thread Turning Inserts Ordering Codes

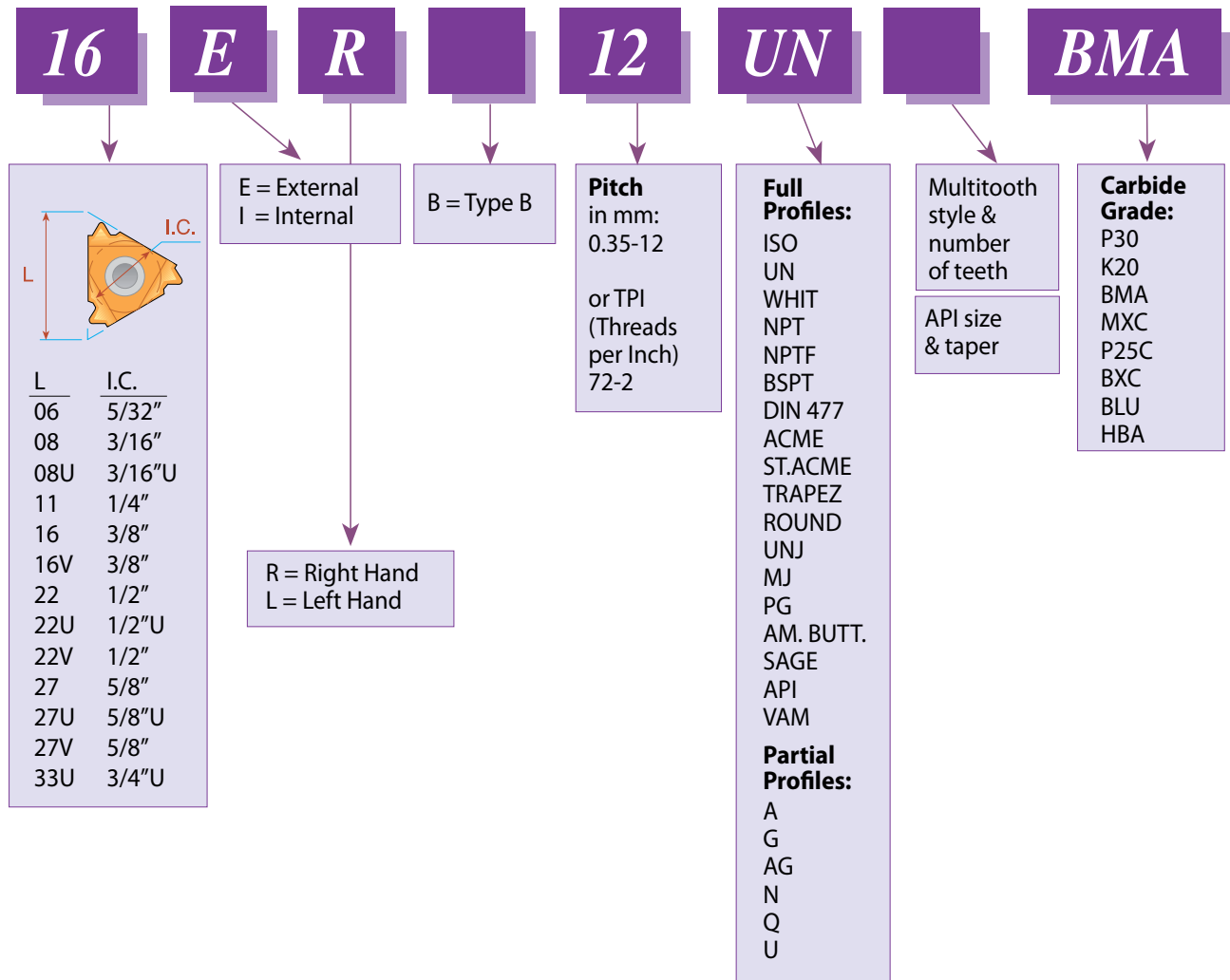

## Partial Profile 60°

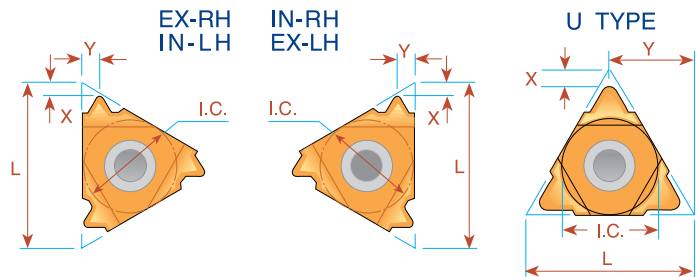
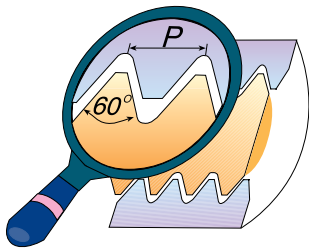

L	I.C. in	Pitch Range		<b>EXTERNAL</b>		<b>INTERNAL</b>		X	Y
		mm	TPI	Ordering Code Right Hand	Ordering Code Left Hand	Ordering Code Right Hand	Ordering Code Left Hand		
6	5/32	0.5 - 1.25	48 - 20	ULTRA MINIATURE →		*06 IR A60	*06 IL A60	0.6	0.6
8	3/16	0.5 - 1.5	48 - 16	MINIATURE →		*08 IR A60	*08 IL A60	0.6	0.7
8U	3/16U	1.75 - 2.0	14 - 11	"U" MINIATURE →		*08U IR/L U60		0.8	4.0
11	1/4	0.5 - 1.5	48 - 16	11 ER A60	11 EL A60	11 IR A60	11 IL A60	0.8	0.9
16	3/8	0.5 - 1.5	48 - 16	16 ER A60	16 EL A60	16 IR A60	16 IL A60	0.8	0.9
16	3/8	1.75 - 3.0	14 - 8	16 ER G60	16 EL G60	16 IR G60	16 IL G60	1.2	1.7
16	3/8	0.5 - 3.0	48 - 8	16 ER AG60	16 EL AG60	16 IR AG60	16 IL AG60	1.2	1.7
22	1/2	3.5 - 5.0	7 - 5	22 ER N60	22 EL N60	22 IR N60	22 IL N60	1.7	2.5
22U	1/2U	5.5 - 8.0	4.5 - 3.25	22U E/R/L U60				0.6	11.0
27	5/8	5.5 - 6.0	4.5 - 4	27 ER Q60	27 EL Q60	27 IR Q60	27 IL Q60	2.1	3.1
27U	5/8U	6.5 - 9.0	4 - 2.75	27U E/R/L U60				1.0	13.7

\* Available only in BXC and BMA grades

Order example: 16 ER G60 MXC

For small bore threading see page A06-12



## Type B

Ground profile with sintered chip-breaker



L	I.C. in	Pitch Range		<b>EXTERNAL</b>	<b>INTERNAL</b>	X	Y
		mm	TPI	Ordering Code Right Hand	Ordering Code Right Hand		
16	3/8	0.5 - 1.5	48 - 16	16 ER B A60	16 IR B A60	0.8	0.9
16	3/8	1.75 - 3.0	14 - 8	16 ER B G60	16 IR B G60	1.2	1.7
16	3/8	0.5 - 3.0	48 - 8	16 ER B AG60	16 IR B AG60	1.2	1.7

Order example: 16 ER B G60 BMA

For carbide grade and cutting speed see page A04-2 and 3

## Partial Profile 60° Vertical

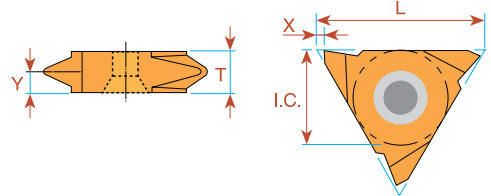

L	I.C. in	Pitch Range		<b>EXTERNAL</b> Ordering Code		<b>INTERNAL</b> Ordering Code		X	Y	T
		mm	TPI	Right Hand	Left Hand	Right Hand	Left Hand			
16	3/8	0.5 - 1.5	48 - 16	<b>16V ER A60</b>	<b>16V EL A60</b>			1.0	0.9	3.6
16	3/8	1.75 - 3.0	14 - 8	<b>16V ER G60</b>	<b>16V EL G60</b>			1.0	1.8	3.6
16	3/8	0.5 - 3.0	48 - 8	<b>16V ER AG60</b>	<b>16V EL AG60</b>			1.0	1.8	3.6
22	1/2	1.75 - 3.0	14 - 8	<b>22V ER G60</b>	<b>22V EL G60</b>			1.2	1.7	4.0
22	1/2	3.5 - 5.0	7 - 5	<b>22V ER N60</b>	<b>22V EL N60</b>			1.2	2.5	4.8
27	5/8	6.0 - 10.0	4 - 2.5	<b>27V ER V60</b>	<b>27V EL V60</b>	<b>27V IR V60</b>	<b>27V IL V60</b>	1.8	5.2	10.4

Order example: 16V ER G60 BMA

## Partial Profile 55°

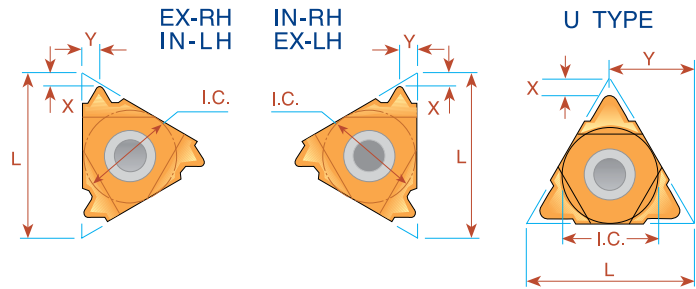
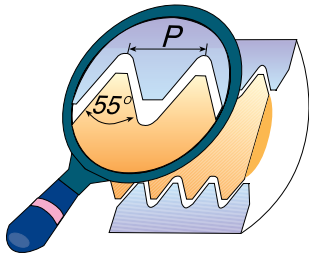

L	I.C. in	Pitch Range		<b>EXTERNAL</b> Ordering Code		<b>INTERNAL</b> Ordering Code		X	Y
		mm	TPI	Right Hand	Left Hand	Right Hand	Left Hand		
6	5/32	0.5 - 1.25	48 - 20	ULTRA MINIATURE →		*06 IR A55	*06 IL A55	0.5	0.6
8	3/16	0.5 - 1.5	48 - 16	MINIATURE →		*08 IR A55	*08 IL A55	0.6	0.7
8U	3/16U	1.75 - 2.0	14 - 11	"U" MINIATURE →		*08U IR/L U55		0.9	4.0
11	1/4	0.5 - 1.5	48 - 16	11 ER A55	11 EL A55	11 IR A55	11 IL A55	0.8	0.9
16	3/8	0.5 - 1.5	48 - 16	16 ER A55	16 EL A55	16 IR A55	16 IL A55	0.8	0.9
16	3/8	1.75 - 3.0	14 - 8	16 ER G55	16 EL G55	16 IR G55	16 IL G55	1.2	1.7
16	3/8	0.5 - 3.0	48 - 8	16 ER AG55	16 EL AG55	16 IR AG55	16 IL AG55	1.2	1.7
22	1/2	3.5 - 5.0	7 - 5	22 ER N55	22 EL N55	22 IR N55	22 IL N55	1.7	2.5
22U	1/2U	5.5 - 8.0	4.5 - 3.25	22U E/R/L U55				0.9	11.0
27	5/8	5.5 - 6.0	4.5 - 4	27 ER Q55	27 EL Q55	27 IR Q55	27 IL Q55	2.0	2.9
27U	5/8U	6.5 - 9.0	4 - 2.75	27U E/R/L U55				1.2	13.7

\* Available only in BXC and BMA grades

Order example: 16 ER G55 MXC

For small bore threading see page A06-12



## Type B

Ground profile with sintered chip-breaker



L	I.C. in	Pitch Range		<b>EXTERNAL</b>	<b>INTERNAL</b>	X	Y
		mm	TPI	Ordering Code Right Hand	Ordering Code Right Hand		
16	3/8	1.75 - 3.0	14 - 8	16 ER B G55	16 IR B G55	1.2	1.7
16	3/8	0.5 - 3.0	48 - 8	16 ER B AG55	16 IR B AG55	1.2	1.7

Order example: 16 ER B G55 BMA

For carbide grade and cutting speed see page A04-2 and 3

## Partial Profile 55° Vertical

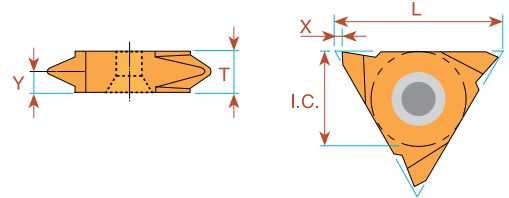

L	I.C. in	Pitch Range		<b>EXTERNAL</b>		<b>INTERNAL</b>		X	Y	T
		mm	TPI	Ordering Code Right Hand	Ordering Code Left Hand	Ordering Code Right Hand	Ordering Code Left Hand			
16	3/8	0.5 - 1.5	48 - 16	<b>16V ER A55</b>	<b>16V EL A55</b>			1.0	0.9	3.6
16	3/8	1.75 - 3.0	14 - 8	<b>16V ER G55</b>	<b>16V EL G55</b>			1.0	1.7	3.6
16	3/8	0.5 - 3.0	48 - 8	<b>16V ER AG55</b>	<b>16V EL AG55</b>			1.0	1.8	3.6
22	1/2	3.5 - 5.0	7 - 5	<b>22V ER N55</b>	<b>22V EL N55</b>			1.2	2.5	4.8
27	5/8	6.0 - 10.0	4 - 2.5	<b>27V ER V55</b>	<b>27V EL V55</b>	<b>27V IR V55</b>	<b>27V IL V55</b>	1.8	5.2	10.4

Order example: 22V ER N55 BMA

# Thread Turning Inserts

## ISO - metric

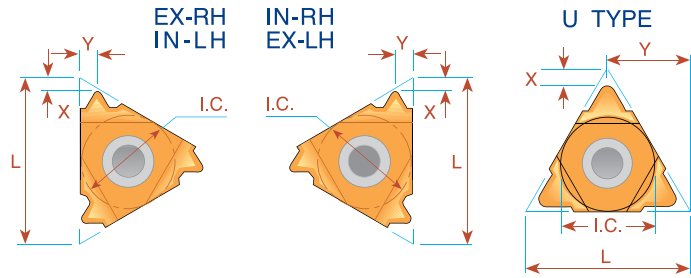
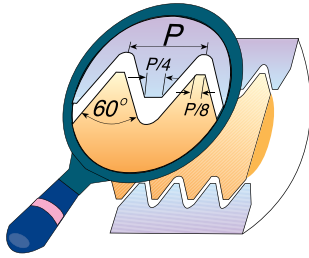

Pitch mm	L	I.C. in	<b>EXTERNAL</b>		X	Y	<b>INTERNAL</b>		X	Y
			Ordering Code Right Hand	Ordering Code Left Hand			Ordering Code Right Hand	Ordering Code Left Hand		
0.25	6	5/32	<i>ULTRA MINIATURE</i> →				*06 IR 0.25 ISO	*06 IL 0.25 ISO	0.7	0.3
0.5	6	5/32					*06 IR 0.5 ISO	*06 IL 0.5 ISO	0.9	0.5
0.75	6	5/32					*06 IR 0.75 ISO	*06 IL 0.75 ISO	0.8	0.5
1.0	6	5/32					*06 IR 1.0 ISO	*06 IL 1.0 ISO	0.7	0.6
1.25	6	5/32					*06 IR 1.25 ISO	*06 IL 1.25 ISO	0.6	0.6
0.25	8	3/16	<i>MINIATURE</i> →				*08 IR 0.25 ISO	*08 IL 0.25 ISO	0.7	0.3
0.5	8	3/16					*08 IR 0.5 ISO	*08 IL 0.5 ISO	0.6	0.5
0.75	8	3/16					*08 IR 0.75 ISO	*08 IL 0.75 ISO	0.6	0.5
1.0	8	3/16					*08 IR 1.0 ISO	*08 IL 1.0 ISO	0.6	0.6
1.25	8	3/16					*08 IR 1.25 ISO	*08 IL 1.25 ISO	0.6	0.7
1.5	8	3/16			*08 IR 1.5 ISO	*08 IL 1.5 ISO	0.6	0.7		
1.75	8	3/16			*08 IR 1.75 ISO	*08 IL 1.75 ISO	0.6	0.8		
2.0	8U	3/16U	<i>"U" MINIATURE</i> →				*08U IR/L 2.0 ISO		0.9	4.0
0.25	11	1/4	11 ER 0.25 ISO	11 EL 0.25 ISO	0.6	0.2				
0.3	11	1/4	11 ER 0.3 ISO	11 EL 0.3 ISO	0.8	0.3				
0.35	11	1/4	11 ER 0.35 ISO	11 EL 0.35 ISO	0.8	0.4	11 IR 0.35 ISO	11 IL 0.35 ISO	0.8	0.3
0.4	11	1/4	11 ER 0.4 ISO	11 EL 0.4 ISO	0.7	0.4	11 IR 0.4 ISO	11 IL 0.4 ISO	0.8	0.4
0.45	11	1/4	11 ER 0.45 ISO	11 EL 0.45 ISO	0.7	0.4	11 IR 0.45 ISO	11 IL 0.45 ISO	0.8	0.4
0.5	11	1/4	11 ER 0.5 ISO	11 EL 0.5 ISO	0.6	0.6	11 IR 0.5 ISO	11 IL 0.5 ISO	0.6	0.6
0.6	11	1/4	11 ER 0.6 ISO	11 EL 0.6 ISO	0.6	0.6	11 IR 0.6 ISO	11 IL 0.6 ISO	0.6	0.6
0.7	11	1/4	11 ER 0.7 ISO	11 EL 0.7 ISO	0.6	0.6	11 IR 0.7 ISO	11 IL 0.7 ISO	0.6	0.6
0.75	11	1/4	11 ER 0.75 ISO	11 EL 0.75 ISO	0.6	0.6	11 IR 0.75 ISO	11 IL 0.75 ISO	0.6	0.6
0.8	11	1/4	11 ER 0.8 ISO	11 EL 0.8 ISO	0.6	0.6	11 IR 0.8 ISO	11 IL 0.8 ISO	0.6	0.6
1.0	11	1/4	11 ER 1.0 ISO	11 EL 1.0 ISO	0.7	0.7	11 IR 1.0 ISO	11 IL 1.0 ISO	0.6	0.7
1.25	11	1/4	11 ER 1.25 ISO	11 EL 1.25 ISO	0.8	0.9	11 IR 1.25 ISO	11 IL 1.25 ISO	0.8	0.8
1.5	11	1/4	11 ER 1.5 ISO	11 EL 1.5 ISO	0.8	1.0	11 IR 1.5 ISO	11 IL 1.5 ISO	0.8	1.0
1.75	11	1/4	11 ER 1.75 ISO	11 EL 1.75 ISO	0.8	1.1	11 IR 1.75 ISO	11 IL 1.75 ISO	0.8	1.1
2.0	11	1/4	11 ER 2.0 ISO	11 EL 2.0 ISO	0.8	1.1	11 IR 2.0 ISO	11 IL 2.0 ISO	0.8	0.9
2.5	11	1/4					11 IR 2.5 ISO	11 IL 2.5 ISO	0.8	1.2
0.25	16	3/8	16 ER 0.25 ISO	16 EL 0.25 ISO	0.6	0.2				
0.3	16	3/8	16 ER 0.3 ISO	16 EL 0.3 ISO	0.8	0.3				
0.35	16	3/8	16 ER 0.35 ISO	16 EL 0.35 ISO	0.8	0.4	16 IR 0.35 ISO	16 IL 0.35 ISO	0.8	0.3
0.4	16	3/8	16 ER 0.4 ISO	16 EL 0.4 ISO	0.7	0.4	16 IR 0.4 ISO	16 IL 0.4 ISO	0.8	0.4
0.45	16	3/8	16 ER 0.45 ISO	16 EL 0.45 ISO	0.7	0.4	16 IR 0.45 ISO	16 IL 0.45 ISO	0.8	0.4
0.5	16	3/8	16 ER 0.5 ISO	16 EL 0.5 ISO	0.6	0.6	16 IR 0.5 ISO	16 IL 0.5 ISO	0.6	0.6
0.6	16	3/8	16 ER 0.6 ISO	16 EL 0.6 ISO	0.6	0.6	16 IR 0.6 ISO	16 IL 0.6 ISO	0.6	0.6
0.7	16	3/8	16 ER 0.7 ISO	16 EL 0.7 ISO	0.6	0.6	16 IR 0.7 ISO	16 IL 0.7 ISO	0.6	0.6
0.75	16	3/8	16 ER 0.75 ISO	16 EL 0.75 ISO	0.6	0.6	16 IR 0.75 ISO	16 IL 0.75 ISO	0.6	0.6
0.8	16	3/8	16 ER 0.8 ISO	16 EL 0.8 ISO	0.6	0.6	16 IR 0.8 ISO	16 IL 0.8 ISO	0.6	0.6
1.0	16	3/8	16 ER 1.0 ISO	16 EL 1.0 ISO	0.7	0.7	16 IR 1.0 ISO	16 IL 1.0 ISO	0.6	0.7
1.25	16	3/8	16 ER 1.25 ISO	16 EL 1.25 ISO	0.8	0.9	16 IR 1.25 ISO	16 IL 1.25 ISO	0.8	0.9
1.5	16	3/8	16 ER 1.5 ISO	16 EL 1.5 ISO	0.8	1.0	16 IR 1.5 ISO	16 IL 1.5 ISO	0.8	1.0
1.75	16	3/8	16 ER 1.75 ISO	16 EL 1.75 ISO	0.9	1.2	16 IR 1.75 ISO	16 IL 1.75 ISO	0.9	1.2
2.0	16	3/8	16 ER 2.0 ISO	16 EL 2.0 ISO	1.0	1.3	16 IR 2.0 ISO	16 IL 2.0 ISO	1.0	1.3
2.5	16	3/8	16 ER 2.5 ISO	16 EL 2.5 ISO	1.1	1.5	16 IR 2.5 ISO	16 IL 2.5 ISO	1.1	1.5
3.0	16	3/8	16 ER 3.0 ISO	16 EL 3.0 ISO	1.2	1.6	16 IR 3.0 ISO	16 IL 3.0 ISO	1.1	1.5
3.5	16	3/8	16 ER 3.5 ISO	16 EL 3.5 ISO	1.2	1.7	16 IR 3.5 ISO	16 IL 3.5 ISO	1.2	1.7

\* Available only in BXC and BMA grades



## ISO - metric

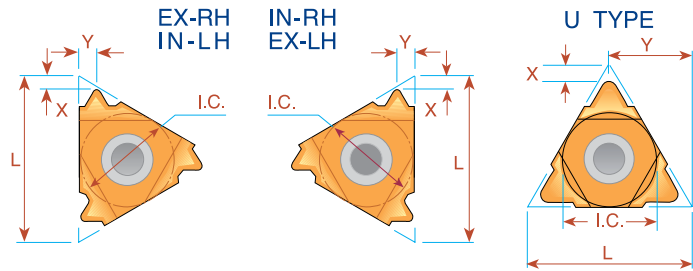
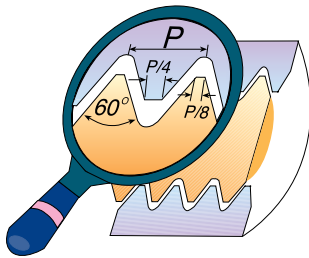

Pitch mm	L	I.C. in	<b>EXTERNAL</b>		X	Y	<b>INTERNAL</b>		X	Y
			Ordering Code Right Hand	Ordering Code Left Hand			Ordering Code Right Hand	Ordering Code Left Hand		
3.5	22	1/2	<b>22 ER 3.5 ISO</b>	<b>22 EL 3.5 ISO</b>	1.6	2.3	<b>22 IR 3.5 ISO</b>	<b>22 IL 3.5 ISO</b>	1.6	2.3
4.0	22	1/2	<b>22 ER 4.0 ISO</b>	<b>22 EL 4.0 ISO</b>	1.6	2.3	<b>22 IR 4.0 ISO</b>	<b>22 IL 4.0 ISO</b>	1.6	2.3
4.5	22	1/2	<b>22 ER 4.5 ISO</b>	<b>22 EL 4.5 ISO</b>	1.7	2.4	<b>22 IR 4.5 ISO</b>	<b>22 IL 4.5 ISO</b>	1.6	2.4
5.0	22	1/2	<b>22 ER 5.0 ISO</b>	<b>22 EL 5.0 ISO</b>	1.7	2.5	<b>22 IR 5.0 ISO</b>	<b>22 IL 5.0 ISO</b>	1.6	2.3
5.5	22	1/2	<b>22 ER 5.5 ISO</b>	<b>22 EL 5.5 ISO</b>	1.7	2.6	<b>22 IR 5.5 ISO</b>	<b>22 IL 5.5 ISO</b>	1.6	2.3
6.0	22	1/2	<b>**22 ER 6.0 ISO</b>	<b>**22 EL 6.0 ISO</b>	1.9	2.7	<b>22 IR 6.0 ISO</b>	<b>22 IL 6.0 ISO</b>	1.6	2.4
5.5	22U	1/2U	<b>22U ER/L 5.5 ISO</b>		2.3	11.0	<b>22U IR/L 5.5 ISO</b>		2.4	11.0
6.0	22U	1/2U	<b>22U ER/L 6.0 ISO</b>		2.6	11.0	<b>22U IR/L 6.0 ISO</b>		2.1	11.0
5.5	27	5/8	<b>27 ER 5.5 ISO</b>	<b>27 EL 5.5 ISO</b>	1.9	2.7	<b>27 IR 5.5 ISO</b>	<b>27 IL 5.5 ISO</b>	1.6	2.3
6.0	27	5/8	<b>27 ER 6.0 ISO</b>	<b>27 EL 6.0 ISO</b>	2.0	2.9	<b>27 IR 6.0 ISO</b>	<b>27 IL 6.0 ISO</b>	1.8	2.5
8.0	27U	5/8U	<b>27U ER/L 8.0 ISO</b>		2.4	13.7	<b>27U IR/L 8.0 ISO</b>		2.4	13.7
12.0	33U	3/4U	<b>33U ER/L 12.0 ISO</b>		2.5	16.5	<b>33U IR/L 12.0 ISO</b>		3.5	16.9

\*\* Special holder required

Order example: 22 IR 3.5 ISO BMA

For small bore threading see page A06-13

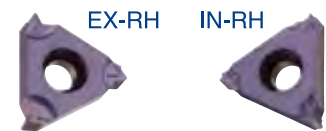
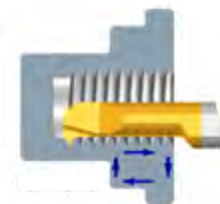

## Type B

Ground profile with sintered chip-breaker

Pitch mm	L	I.C. in	<b>EXTERNAL</b>		X	Y	<b>INTERNAL</b>		X	Y
			Ordering Code Right Hand	Ordering Code Left Hand			Ordering Code Right Hand	Ordering Code Left Hand		
0.5	11	1/4					<b>11 IR B 0.5 ISO</b>		0.6	0.6
0.75	11	1/4					<b>11 IR B 0.75 ISO</b>		0.6	0.6
0.8	11	1/4					<b>11 IR B 0.8 ISO</b>		0.6	0.6
1.0	11	1/4					<b>11 IR B 1.0 ISO</b>		0.6	0.6
1.25	11	1/4					<b>11 IR B 1.25 ISO</b>		0.8	0.9
1.5	11	1/4					<b>11 IR B 1.5 ISO</b>		0.8	0.9
1.75	11	1/4					<b>11 IR B 1.75 ISO</b>		0.8	0.9
2.0	11	1/4					<b>11 IR B 2.0 ISO</b>		0.8	0.9
0.8	16	3/8	<b>16 ER B 0.8 ISO</b>		0.6	0.6				
1.0	16	3/8	<b>16 ER B 1.0 ISO</b>		0.7	0.7	<b>16 IR B 1.0 ISO</b>		0.6	0.7
1.25	16	3/8	<b>16 ER B 1.25 ISO</b>		0.8	0.9	<b>16 IR B 1.25 ISO</b>		0.8	0.9
1.5	16	3/8	<b>16 ER B 1.5 ISO</b>		0.8	1.0	<b>16 IR B 1.5 ISO</b>		0.8	1.0
1.75	16	3/8	<b>16 ER B 1.75 ISO</b>		0.9	1.2	<b>16 IR B 1.75 ISO</b>		0.9	1.2
2.0	16	3/8	<b>16 ER B 2.0 ISO</b>		1.0	1.3	<b>16 IR B 2.0 ISO</b>		1.0	1.3
2.5	16	3/8	<b>16 ER B 2.5 ISO</b>		1.1	1.5	<b>16 IR B 2.5 ISO</b>		1.1	1.5
3.0	16	3/8	<b>16 ER B 3.0 ISO</b>		1.2	1.6	<b>16 IR B 3.0 ISO</b>		1.1	1.5

Order example: 16 IR B 1.5 ISO BMA

For carbide grade and cutting speed see page A04-2 and 3



## ISO - metric Vertical

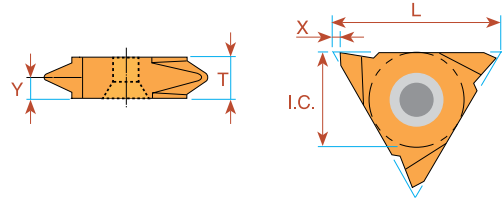

Pitch mm	L	I.C. in	<b>EXTERNAL</b>		<b>INTERNAL</b>		X	Y	T
			Right Hand	Left Hand	Right Hand	Left Hand			
0.5	16	3/8	<b>16V ER 0.5 ISO</b>	<b>16V EL 0.5 ISO</b>			1.0	0.6	3.6
0.75	16	3/8	<b>16V ER 0.75 ISO</b>	<b>16V EL 0.75 ISO</b>			1.0	0.6	3.6
0.8	16	3/8	<b>16V ER 0.8 ISO</b>	<b>16V EL 0.8 ISO</b>			1.0	0.6	3.6
1.0	16	3/8	<b>16V ER 1.0 ISO</b>	<b>16V EL 1.0 ISO</b>			1.0	0.7	3.6
1.25	16	3/8	<b>16V ER 1.25 ISO</b>	<b>16V EL 1.25 ISO</b>			1.0	0.9	3.6
1.5	16	3/8	<b>16V ER 1.5 ISO</b>	<b>16V EL 1.5 ISO</b>			1.0	0.9	3.6
1.75	16	3/8	<b>16V ER 1.75 ISO</b>	<b>16V EL 1.75 ISO</b>			1.0	1.2	3.6
2.0	16	3/8	<b>16V ER 2.0 ISO</b>	<b>16V EL 2.0 ISO</b>			1.0	1.3	3.6
2.5	16	3/8	<b>16V ER 2.5 ISO</b>	<b>16V EL 2.5 ISO</b>			1.0	1.5	3.6
3.0	16	3/8	<b>16V ER 3.0 ISO</b>	<b>16V EL 3.0 ISO</b>			1.0	1.7	3.6
* 8.0	27	5/8	<b>27V ER 8.0 ISO</b>	<b>27V EL 8.0 ISO</b>	<b>27V IR 8.0 ISO</b>	<b>27V IL 8.0 ISO</b>	1.8	5.2	10.4
** 10.0	27	5/8	<b>27V ER 10.0 ISO</b>	<b>27V EL 10.0 ISO</b>	<b>27V IR 10.0 ISO</b>	<b>27V IL 10.0 ISO</b>	1.8	5.2	10.4

Order example: 16V ER 1.5 ISO BMA

\* Minimum bore: Ø60 mm

\*\* Minimum bore: Ø72 mm

## Multitooth

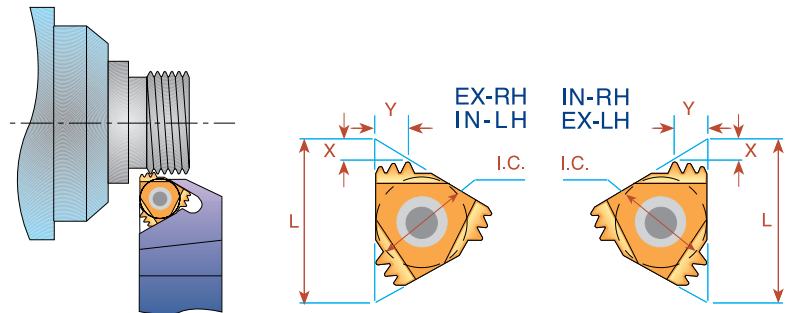

Pitch mm	L	I.C. in	Number of Teeth	<b>EXTERNAL</b>	Anvil	<b>INTERNAL</b>	Anvil	X	Y
				Ordering Code		Ordering Code			
1.0	16	3/8	3	<b>16 ER 1.0 ISO 3M</b>	AE16M	<b>16 IR 1.0 ISO 3M</b>	AI16M	1.7	2.5
1.5	16	3/8	2	<b>16 ER 1.5 ISO 2M</b>	AE16M	<b>16 IR 1.5 ISO 2M</b>	AI16M	1.5	2.3
2.0	16	3/8	2	<b>16 ER 2.0 ISO 2M</b>	AE16M	<b>16 IR 2.0 ISO 2M</b>	AI16M	2.0	3.0
1.5	22	1/2	3	<b>22 ER 1.5 ISO 3M</b>	AE22M	<b>22 IR 1.5 ISO 3M</b>	AI22M	2.3	3.7
2.0	22	1/2	2	<b>22 ER 2.0 ISO 2M</b>	AE22M	<b>22 IR 2.0 ISO 2M</b>	AI22M	2.0	3.0
2.0	22	1/2	3	<b>22 ER 2.0 ISO 3M</b>	AE22M	<b>22 IR 2.0 ISO 3M</b>	AI22M	3.1	5.0
2.0	22	1/2	2	<b>22 ER 2.5 ISO 2M</b>	AE22M	<b>22 IR 2.5 ISO 2M</b>	AI22M	2.4	3.7
2.5	22	1/2	3	<b>22 ER 2.5 ISO 3M</b>	AE22M	<b>22 IR 2.5 ISO 3M</b>	AI22M	3.8	6.2
3.0	27	5/8	2	<b>27 ER 3.0 ISO 2M</b>	AE27M	<b>27 IR 3.0 ISO 2M</b>	AI27M	2.9	4.6

Order example: 22 IR 2.0 ISO 2M BMA

For recommended number of passes see page A04-4

For carbide grade and cutting speed see page A04-2 and 3

## UN - Unified UNC, UNF, UNEF, UNS

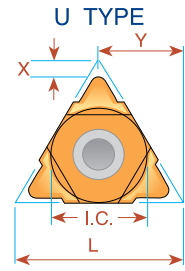
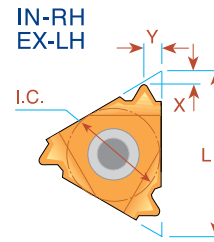
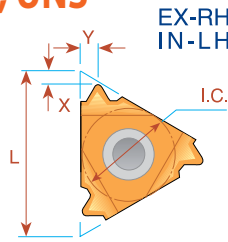
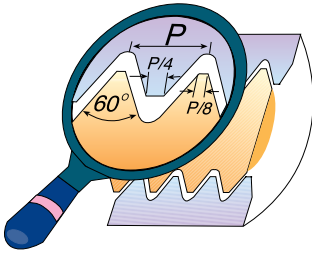

Pitch TPI	L	I.C. in	EXTERNAL		X	Y	INTERNAL		X	Y
			Ordering Code Right Hand	Ordering Code Left Hand			Ordering Code Right Hand	Ordering Code Left Hand		
32	6	5/32	<i>ULTRA MINIATURE</i> →				*06 IR 32 UN	*06 IL 32 UN	0.8	0.5
28	6	5/32					*06 IR 28 UN	*06 IL 28 UN	0.8	0.6
24	6	5/32					*06 IR 24 UN	*06 IL 24 UN	0.7	0.6
20	6	5/32					*06 IR 20 UN	*06 IL 20 UN	0.6	0.6
18	6	5/32					*06 IR 18 UN	*06 IL 18 UN	0.6	0.7
32	8	3/16	<i>MINIATURE</i> →				*08 IR 32 UN	*08 IL 32 UN	0.6	0.5
28	8	3/16					*08 IR 28 UN	*08 IL 28 UN	0.6	0.6
24	8	3/16					*08 IR 24 UN	*08 IL 24 UN	0.6	0.6
20	8	3/16					*08 IR 20 UN	*08 IL 20 UN	0.6	0.7
18	8	3/16					*08 IR 18 UN	*08 IL 18 UN	0.6	0.7
16	8	3/16					*08 IR 16 UN	*08 IL 16 UN	0.6	0.7
14	8	3/16				*08 IR 14 UN	*08 IL 14 UN	0.6	0.8	
13	8	3/16				**08 IR 13 UN		0.8	0.9	
13	8U	3/16U	<i>"U" MINIATURE</i> →				*08U IR/L 13 UN		1.0	4.0
12	8U	3/16U					*08U IR/L 12 UN		0.9	4.0
11	8U	3/16U					*08U IR/L 11 UN		0.9	4.0
80	11	1/4	11 ER 80 UN	11 EL 80 UN	0.8	0.4	11 IR 80 UN	11 IL 80 UN	0.8	0.4
72	11	1/4	11 ER 72 UN	11 EL 72 UN	0.8	0.4	11 IR 72 UN	11 IL 72 UN	0.8	0.3
64	11	1/4	11 ER 64 UN	11 EL 64 UN	0.8	0.4	11 IR 64 UN	11 IL 64 UN	0.8	0.4
56	11	1/4	11 ER 56 UN	11 EL 56 UN	0.7	0.4	11 IR 56 UN	11 IL 56 UN	0.7	0.4
48	11	1/4	11 ER 48 UN	11 EL 48 UN	0.6	0.6	11 IR 48 UN	11 IL 48 UN	0.6	0.6
44	11	1/4	11 ER 44 UN	11 EL 44 UN	0.6	0.6	11 IR 44 UN	11 IL 44 UN	0.6	0.6
40	11	1/4	11 ER 40 UN	11 EL 40 UN	0.6	0.6	11 IR 40 UN	11 IL 40 UN	0.6	0.6
36	11	1/4	11 ER 36 UN	11 EL 36 UN	0.6	0.6	11 IR 36 UN	11 IL 36 UN	0.6	0.6
32	11	1/4	11 ER 32 UN	11 EL 32 UN	0.6	0.6	11 IR 32 UN	11 IL 32 UN	0.6	0.6
28	11	1/4	11 ER 28 UN	11 EL 28 UN	0.6	0.7	11 IR 28 UN	11 IL 28 UN	0.6	0.7
27	11	1/4	11 ER 27 UN	11 EL 27 UN	0.7	0.8	11 IR 27 UN	11 IL 27 UN	0.7	0.8
24	11	1/4	11 ER 24 UN	11 EL 24 UN	0.7	0.8	11 IR 24 UN	11 IL 24 UN	0.7	0.8
20	11	1/4	11 ER 20 UN	11 EL 20 UN	0.8	0.9	11 IR 20 UN	11 IL 20 UN	0.8	0.9
18	11	1/4	11 ER 18 UN	11 EL 18 UN	0.8	1.0	11 IR 18 UN	11 IL 18 UN	0.8	1.0
16	11	1/4	11 ER 16 UN	11 EL 16 UN	0.9	1.1	11 IR 16 UN	11 IL 16 UN	0.9	1.1
14	11	1/4	11 ER 14 UN	11 EL 14 UN	0.9	1.1	11 IR 14 UN	11 IL 14 UN	0.9	1.1
13	11	1/4					11 IR 13 UN	11 IL 13 UN	0.8	1.0
12	11	1/4					11 IR 12 UN	11 IL 12 UN	0.9	1.1
11	11	1/4					11 IR 11 UN	11 IL 11 UN	0.8	1.1
80	16	3/8	16 ER 80 UN	16 EL 80 UN	0.8	0.4	16 IR 80 UN	16 IL 80 UN	0.8	0.4
72	16	3/8	16 ER 72 UN	16 EL 72 UN	0.8	0.4	16 IR 72 UN	16 IL 72 UN	0.8	0.3
64	16	3/8	16 ER 64 UN	16 EL 64 UN	0.8	0.4	16 IR 64 UN	16 IL 64 UN	0.8	0.4
56	16	3/8	16 ER 56 UN	16 EL 56 UN	0.7	0.4	16 IR 56 UN	16 IL 56 UN	0.7	0.4
48	16	3/8	16 ER 48 UN	16 EL 48 UN	0.6	0.6	16 IR 48 UN	16 IL 48 UN	0.6	0.6
44	16	3/8	16 ER 44 UN	16 EL 44 UN	0.6	0.6	16 IR 44 UN	16 IL 44 UN	0.6	0.6
40	16	3/8	16 ER 40 UN	16 EL 40 UN	0.6	0.6	16 IR 40 UN	16 IL 40 UN	0.6	0.6
36	16	3/8	16 ER 36 UN	16 EL 36 UN	0.6	0.6	16 IR 36 UN	16 IL 36 UN	0.6	0.6

\* Available only in BXC and BMA grades

\*\* To be used with Holder SIR 0009 K08 on page A02-10

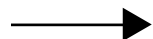

# Thread Turning Inserts

## UN - Unified **UNC, UNF, UNEF, UNS**

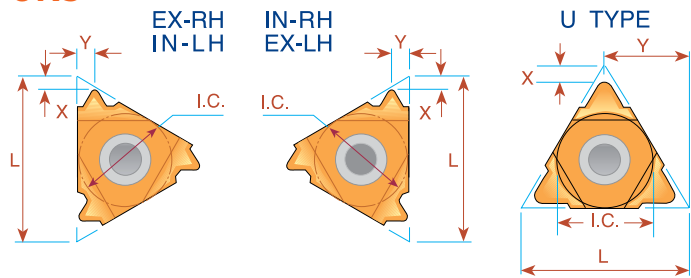
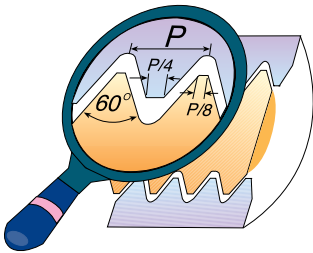

Pitch TPI	L	I.C. in	<b>EXTERNAL</b>				X	Y	<b>INTERNAL</b>				X	Y
			Ordering Code		Right Hand	Left Hand			Ordering Code		Right Hand	Left Hand		
			Right Hand	Left Hand					Right Hand	Left Hand				
32	16	3/8	16 ER 32 UN	16 EL 32 UN	0.6	0.6	16 IR 32 UN	16 IL 32 UN	0.6	0.6				
28	16	3/8	16 ER 28 UN	16 EL 28 UN	0.6	0.7	16 IR 28 UN	16 IL 28 UN	0.6	0.7				
27	16	3/8	16 ER 27 UN	16 EL 27 UN	0.7	0.8	16 IR 27 UN	16 IL 27 UN	0.7	0.8				
24	16	3/8	16 ER 24 UN	16 EL 24 UN	0.7	0.8	16 IR 24 UN	16 IL 24 UN	0.7	0.8				
20	16	3/8	16 ER 20 UN	16 EL 20 UN	0.8	0.9	16 IR 20 UN	16 IL 20 UN	0.8	0.9				
18	16	3/8	16 ER 18 UN	16 EL 18 UN	0.8	1.0	16 IR 18 UN	16 IL 18 UN	0.8	1.0				
16	16	3/8	16 ER 16 UN	16 EL 16 UN	0.9	1.1	16 IR 16 UN	16 IL 16 UN	0.9	1.1				
14	16	3/8	16 ER 14 UN	16 EL 14 UN	1.0	1.2	16 IR 14 UN	16 IL 14 UN	0.9	1.2				
13	16	3/8	16 ER 13 UN	16 EL 13 UN	1.0	1.3	16 IR 13 UN	16 IL 13 UN	1.0	1.3				
12	16	3/8	16 ER 12 UN	16 EL 12 UN	1.1	1.4	16 IR 12 UN	16 IL 12 UN	1.1	1.4				
11.5	16	3/8	16 ER 11.5 UN	16 EL 11.5 UN	1.1	1.5	16 IR 11.5 UN	16 IL 11.5 UN	1.1	1.5				
11	16	3/8	16 ER 11 UN	16 EL 11 UN	1.1	1.5	16 IR 11 UN	16 IL 11 UN	1.1	1.5				
10	16	3/8	16 ER 10 UN	16 EL 10 UN	1.1	1.5	16 IR 10 UN	16 IL 10 UN	1.1	1.5				
9	16	3/8	16 ER 9 UN	16 EL 9 UN	1.2	1.7	16 IR 9 UN	16 IL 9 UN	1.2	1.7				
8	16	3/8	16 ER 8 UN	16 EL 8 UN	1.2	1.6	16 IR 8 UN	16 IL 8 UN	1.1	1.5				
7	22	1/2	22 ER 7 UN	22 EL 7 UN	1.6	2.3	22 IR 7 UN	22 IL 7 UN	1.6	2.3				
6	22	1/2	22 ER 6 UN	22 EL 6 UN	1.6	2.3	22 IR 6 UN	22 IL 6 UN	1.6	2.3				
5	22	1/2	22 ER 5 UN	22 EL 5 UN	1.7	2.5	22 IR 5 UN	22 IL 5 UN	1.6	2.3				
4.5	22U	1/2U	22U ER/L 4.5 UN		2.0	11.0	22U IR/L 4.5 UN		2.4	11.0				
4	22U	1/2U	22U ER/L 4 UN		2.0	11.0	22U IR/L 4 UN		2.4	11.0				
4.5	27	5/8	27 ER 4.5 UN	27 EL 4.5 UN	1.9	2.7	27 IR 4.5 UN	27 IL 4.5 UN	1.7	2.4				
4	27	5/8	27 ER 4 UN	27 EL 4 UN	2.1	3.0	27 IR 4 UN	27 IL 4 UN	1.8	2.7				
3	27U	5/8U	27U ER/L 3 UN		2.5	13.7	27U IR/L 3 UN		2.7	13.7				
2	33U	3/4U	33U ER/L 2 UN		2.8	16.5	33U IR/L 2 UN		3.6	16.9				

Order example: 22ER 7 UN BMA

For small bore threading see page A06-13

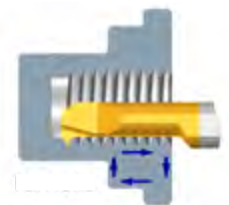

For carbide grade and cutting speed see page A04-2 and 3

## UN - Unified Vertical

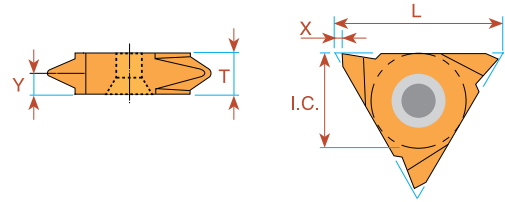

Pitch TPI	L	I.C. in	<b>EXTERNAL</b>		<b>INTERNAL</b>		X	Y	T
			Ordering Code Right Hand	Ordering Code Left Hand	Ordering Code Right Hand	Ordering Code Left Hand			
32	16	3/8	16V ER 32 UN	16V EL 32 UN			1.0	0.6	3.6
28	16	3/8	16V ER 28 UN	16V EL 28 UN			1.0	0.7	3.6
24	16	3/8	16V ER 24 UN	16V EL 24 UN			1.0	0.8	3.6
20	16	3/8	16V ER 20 UN	16V EL 20 UN			1.0	0.9	3.6
18	16	3/8	16V ER 18 UN	16V EL 18 UN			1.0	1.0	3.6
16	16	3/8	16V ER 16 UN	16V EL 16 UN			1.0	1.1	3.6
14	16	3/8	16V ER 14 UN	16V EL 14 UN			1.0	1.2	3.6
12	16	3/8	16V ER 12 UN	16V EL 12 UN			1.0	1.4	3.6
10	16	3/8	16V ER 10 UN	16V EL 10 UN			1.0	1.5	3.6
8	16	3/8	16V ER 8 UN	16V EL 8 UN			1.0	1.6	3.6
7	22	1/2	22V ER 7 UN	22V EL 7 UN			1.2	2.3	4.8
* 3	27	5/8	27V ER 3 UN	27V EL 3 UN	27V IR 3 UN	27V IL 3 UN	1.8	5.2	10.4

\* Minimum bore: Ø65 mm

Order example: 22V ER 7UN MXC

## UN - Unified Type B UNC, UNF, UNEF, UNS

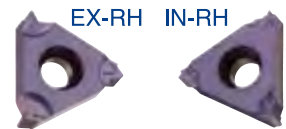

**Ground profile with sintered chip-breaker**

Pitch TPI	L	I.C. in	<b>EXTERNAL</b>		X	Y	<b>INTERNAL</b>		X	Y
			Ordering Code Right Hand				Ordering Code Right Hand			
32	11	1/4					11 IR B 32 UN	0.6	0.6	
28	11	1/4					11 IR B 28 UN	0.6	0.6	
24	11	1/4					11 IR B 24 UN	0.6	0.6	
20	11	1/4					11 IR B 20 UN	0.8	0.9	
18	11	1/4					11 IR B 18 UN	0.8	0.9	
16	11	1/4					11 IR B 16 UN	0.8	0.9	
14	11	1/4					11 IR B 14 UN	0.8	0.9	
12	11	1/4					11 IR B 12 UN	0.8	0.9	
24	16	3/8	16 ER B 24 UN		0.7	0.8	16 IR B 24 UN	0.7	0.8	
20	16	3/8	16 ER B 20 UN		0.8	0.9	16 IR B 20 UN	0.8	0.9	
18	16	3/8	16 ER B 18 UN		0.8	1.0	16 IR B 18 UN	0.8	1.0	
16	16	3/8	16 ER B 16 UN		0.9	1.1	16 IR B 16 UN	0.9	1.1	
14	16	3/8	16 ER B 14 UN		1.0	1.2	16 IR B 14 UN	0.9	1.2	
13	16	3/8	16 ER B 13 UN		1.0	1.3				
12	16	3/8	16 ER B 12 UN		1.1	1.4	16 IR B 12 UN	1.1	1.4	
11	16	3/8	16 ER B 11 UN		1.1	1.5				
10	16	3/8	16 ER B 10 UN		1.1	1.5	16 IR B 10 UN	1.1	1.5	
9	16	3/8	16 ER B 9 UN		1.2	1.7				
8	16	3/8	16 ER B 8 UN		1.2	1.6	16 IR B 8 UN	1.1	1.1	

Order example: 16 IR B 12 UN BMA

## Multitooth

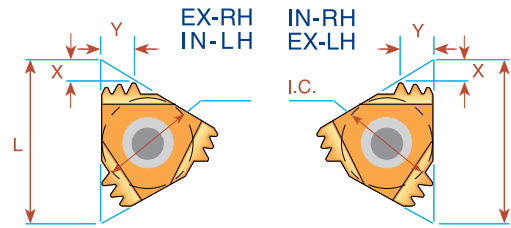
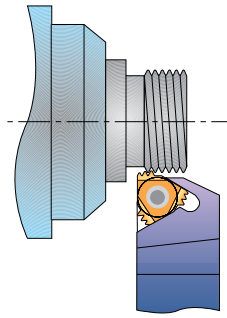

Pitch TPI	L	I.C. in	Number of Teeth	<b>EXTERNAL</b>	Anvil	<b>INTERNAL</b>	Anvil	X	Y
				Ordering Code		Ordering Code			
24	16	3/8	2	<b>16 ER 24 UN 2M</b>	AE16M	<b>16 IR 24 UN 2M</b>	AI16M	1.1	1.7
20	16	3/8	2	<b>16 ER 20 UN 2M</b>	AE16M	<b>16 IR 20 UN 2M</b>	AI16M	1.4	2.0
18	16	3/8	2	<b>16 ER 18 UN 2M</b>	AE16M	<b>16 IR 18 UN 2M</b>	AI16M	1.5	2.2
16	16	3/8	2	<b>16 ER 16 UN 2M</b>	AE16M	<b>16 IR 16 UN 2M</b>	AI16M	1.5	2.3
14	16	3/8	2	<b>16 ER 14 UN 2M</b>	AE16M	<b>16 IR 14 UN 2M</b>	AI16M	1.7	2.7
12	16	3/8	2	<b>16 ER 12 UN 2M</b>	AE16M	<b>16 IR 12 UN 2M</b>	AI16M	2.0	3.1
16	22	1/2	3	<b>22 ER 16 UN 3M</b>	AE22M	<b>22 IR 16 UN 3M</b>	AI22M	2.5	4.0
13	22	1/2	3	<b>22 ER 13 UN 3M</b>	AE22M	-		3.0	4.9
12	22	1/2	2	<b>22 ER 12 UN 2M</b>	AE22M	<b>22 IR 12 UN 2M</b>	AI22M	2.2	3.4
12	22	1/2	3	<b>22 ER 12 UN 3M</b>	AE22M	<b>22 IR 12 UN 3M</b>	AI22M	3.3	5.3
8	27	5/8	2	<b>27 ER 8 UN 2M</b>	AE27M	<b>27 IR 8 UN 2M</b>	AI27M	3.1	4.9

Order example: 22 IR 16 UN 3M BMA

For recommended number of passes see page A04-4

## Whitworth - 55° BSW, BSF, BSP, BSB

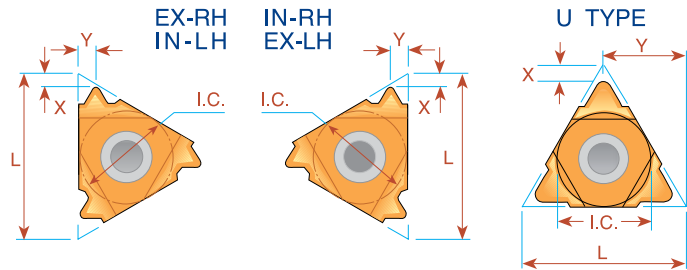
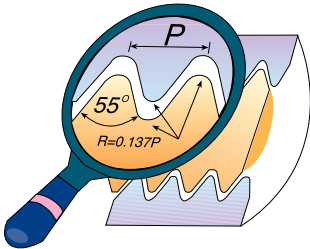

Pitch TPI	L	I.C. in	<b>EXTERNAL</b>		<b>INTERNAL</b>		X	Y
			Right Hand	Left Hand	Right Hand	Left Hand		
26	6	5/32	<i>ULTRA MINIATURE</i> →		*06 IR 26 W	*06 IL 26 W	0.7	0.6
22	6	5/32			*06 IR 22 W	*06 IL 22 W	0.6	0.6
20	6	5/32			*06 IR 20 W	*06 IL 20 W	0.6	0.7
18	6	5/32			*06 IR 18 W	*06 IL 18 W	0.6	0.7
28	8	3/16	<i>MINIATURE</i> →		*08 IR 28 W	*08 IL 28 W	0.6	0.6
24	8	3/16			*08 IR 24 W	*08 IL 24 W	0.6	0.6
20	8	3/16			*08 IR 20 W	*08 IL 20 W	0.6	0.7
19	8	3/16			*08 IR 19 W	*08 IL 19 W	0.6	0.7
18	8	3/16			*08 IR 18 W	*08 IL 18 W	0.6	0.7
16	8	3/16			*08 IR 16 W	*08 IL 16 W	0.6	0.7
14	8U	3/16U	<i>"U" MINIATURE</i> →		*08U IR/L 14 W		1.0	4.0
12	8U	3/16U			*08U IR/L 12 W		0.9	4.0
11	8U	3/16U			*08U IR/L 11 W		0.9	4.0
72	11	1/4	11 ER 72 W	11 EL 72 W	11 IR 72 W	11 IL 72 W	0.7	0.4
60	11	1/4	11 ER 60 W	11 EL 60 W	11 IR 60 W	11 IL 60 W	0.7	0.4
56	11	1/4	11 ER 56 W	11 EL 56 W	11 IR 56 W	11 IL 56 W	0.7	0.4
48	11	1/4	11 ER 48 W	11 EL 48 W	11 IR 48 W	11 IL 48 W	0.6	0.6
40	11	1/4	11 ER 40 W	11 EL 40 W	11 IR 40 W	11 IL 40 W	0.6	0.6
36	11	1/4	11 ER 36 W	11 EL 36 W	11 IR 36 W	11 IL 36 W	0.6	0.6
32	11	1/4	11 ER 32 W	11 EL 32 W	11 IR 32 W	11 IL 32 W	0.6	0.6
28	11	1/4	11 ER 28 W	11 EL 28 W	11 IR 28 W	11 IL 28 W	0.6	0.7
26	11	1/4	11 ER 26 W	11 EL 26 W	11 IR 26 W	11 IL 26 W	0.7	0.7
24	11	1/4	11 ER 24 W	11 EL 24 W	11 IR 24 W	11 IL 24 W	0.7	0.8
22	11	1/4	11 ER 22 W	11 EL 22 W	11 IR 22 W	11 IL 22 W	0.8	0.9
20	11	1/4	11 ER 20 W	11 EL 20 W	11 IR 20 W	11 IL 20 W	0.8	0.9
19	11	1/4	11 ER 19 W	11 EL 19 W	11 IR 19 W	11 IL 19 W	0.8	1.0
18	11	1/4	11 ER 18 W	11 EL 18 W	11 IR 18 W	11 IL 18 W	0.8	1.0
16	11	1/4	11 ER 16 W	11 EL 16 W	11 IR 16 W	11 IL 16 W	0.9	1.1
14	11	1/4	11 ER 14 W	11 EL 14 W	11 IR 14 W	11 IL 14 W	0.9	1.1
12	11	1/4			11 IR 12 W	11 IL 12 W	0.1	1.1
11	11	1/4			<sup>(1)</sup> 11 IR 11 W	<sup>(1)</sup> 11 IL 11 W	0.9	1.2
72	16	3/8	16 ER 72 W	16 EL 72 W	16 IR 72 W	16 IL 72 W	0.7	0.4
60	16	3/8	16 ER 60 W	16 EL 60 W	16 IR 60 W	16 IL 60 W	0.7	0.4
56	16	3/8	16 ER 56 W	16 EL 56 W	16 IR 56 W	16 IL 56 W	0.7	0.4
48	16	3/8	16 ER 48 W	16 EL 48 W	16 IR 48 W	16 IL 48 W	0.6	0.6
40	16	3/8	16 ER 40 W	16 EL 40 W	16 IR 40 W	16 IL 40 W	0.6	0.6
36	16	3/8	16 ER 36 W	16 EL 36 W	16 IR 36 W	16 IL 36 W	0.6	0.6
32	16	3/8	16 ER 32 W	16 EL 32 W	16 IR 32 W	16 IL 32 W	0.6	0.6
28	16	3/8	16 ER 28 W	16 EL 28 W	16 IR 28 W	16 IL 28 W	0.6	0.7
26	16	3/8	16 ER 26 W	16 EL 26 W	16 IR 26 W	16 IL 26 W	0.7	0.7
24	16	3/8	16 ER 24 W	16 EL 24 W	16 IR 24 W	16 IL 24 W	0.7	0.8

\* Available only in BXC and BMA grades

(1) Special holder is required or standard holder can be amended by customer.

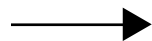



## Whitworth - 55° BSW, BSF, BSP, BSB

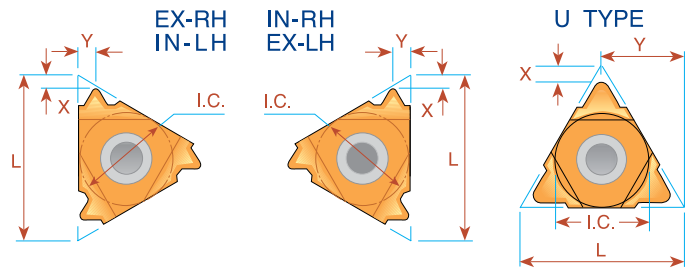
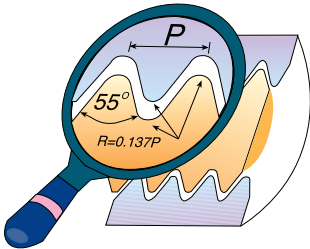

Pitch TPI	L	I.C. in	<b>EXTERNAL</b>		<b>INTERNAL</b>		X	Y
			Right Hand	Left Hand	Right Hand	Left Hand		
22	16	3/8	<b>16 ER 22 W</b>	<b>16 EL 22 W</b>	<b>16 IR 22 W</b>	<b>16 IL 22 W</b>	0.8	0.9
20	16	3/8	<b>16 ER 20 W</b>	<b>16 EL 20 W</b>	<b>16 IR 20 W</b>	<b>16 IL 20 W</b>	0.8	0.9
19	16	3/8	<b>16 ER 19 W</b>	<b>16 EL 19 W</b>	<b>16 IR 19 W</b>	<b>16 IL 19 W</b>	0.8	1.0
18	16	3/8	<b>16 ER 18 W</b>	<b>16 EL 18 W</b>	<b>16 IR 18 W</b>	<b>16 IL 18 W</b>	0.8	1.0
16	16	3/8	<b>16 ER 16 W</b>	<b>16 EL 16 W</b>	<b>16 IR 16 W</b>	<b>16 IL 16 W</b>	0.9	1.1
14	16	3/8	<b>16 ER 14 W</b>	<b>16 EL 14 W</b>	<b>16 IR 14 W</b>	<b>16 IL 14 W</b>	1.0	1.2
12	16	3/8	<b>16 ER 12 W</b>	<b>16 EL 12 W</b>	<b>16 IR 12 W</b>	<b>16 IL 12 W</b>	1.1	1.4
11	16	3/8	<b>16 ER 11 W</b>	<b>16 EL 11 W</b>	<b>16 IR 11 W</b>	<b>16 IL 11 W</b>	1.1	1.5
10	16	3/8	<b>16 ER 10 W</b>	<b>16 EL 10 W</b>	<b>16 IR 10 W</b>	<b>16 IL 10 W</b>	1.1	1.5
9	16	3/8	<b>16 ER 9 W</b>	<b>16 EL 9 W</b>	<b>16 IR 9 W</b>	<b>16 IL 9 W</b>	1.2	1.7
8	16	3/8	<b>16 ER 8 W</b>	<b>16 EL 8 W</b>	<b>16 IR 8 W</b>	<b>16 IL 8 W</b>	1.2	1.5
7	22	1/2	<b>22 ER 7 W</b>	<b>22 EL 7 W</b>	<b>22 IR 7 W</b>	<b>22 IL 7 W</b>	1.6	2.3
6	22	1/2	<b>22 ER 6 W</b>	<b>22 EL 6 W</b>	<b>22 IR 6 W</b>	<b>22 IL 6 W</b>	1.6	2.3
5	22	1/2	<b>22 ER 5 W</b>	<b>22 EL 5 W</b>	<b>22 IR 5 W</b>	<b>22 IL 5 W</b>	1.7	2.4
4.5	22U	1/2U	<b>22U E//R/L 4.5 W</b>				2.3	11.0
4	22U	1/2U	<b>22U E//R/L 4 W</b>				2.8	11.0
4.5	27	5/8	<b>27 ER 4.5 W</b>	<b>27 EL 4.5 W</b>	<b>27 IR 4.5 W</b>	<b>27 IL 4.5 W</b>	1.8	2.6
4	27	5/8	<b>27 ER 4 W</b>	<b>27 EL 4 W</b>	<b>27 IR 4 W</b>	<b>27 IL 4 W</b>	2.0	2.9
3.5	27U	5/8U	<b>27U E//R/L 3.5 W</b>				2.1	13.7
3.25	27U	5/8U	<b>27U E//R/L 3.25 W</b>				2.0	13.7
3	27U	5/8U	<b>27U E//R/L 3 W</b>				2.3	13.7
2.75	27U	5/8U	<b>27U E//R/L 2.75 W</b>				2.4	13.7
*2.625	27U	5/8U	<b>27U E//R/L 2.625 W</b>				2.5	13.7
*2.5	27U	5/8U	<b>27U E//R/L 2.5 W</b>				2.8	13.7

\* One cutting edge

Order example: 16 IR 18 W BMA



## Whitworth - 55° BSW, BSF, BSP, BSB

### Type B

Ground profile with sintered chip-breaker

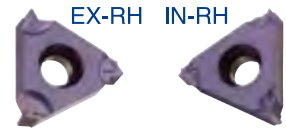

Pitch TPI	L	I.C. in	<b>EXTERNAL</b>	<b>INTERNAL</b>	X	Y
			Ordering Code Right Hand	Ordering Code Right Hand		
28	11	1/4		<b>11 IR B 28 W</b>	0.6	0.6
24	11	1/4		<b>11 IR B 24 W</b>	0.6	0.6
20	11	1/4		<b>11 IR B 20 W</b>	0.8	0.9
19	11	1/4		<b>11 IR B 19 W</b>	0.8	0.9
18	11	1/4		<b>11 IR B 18 W</b>	0.8	0.9
16	11	1/4		<b>11 IR B 16 W</b>	0.8	0.9
14	11	1/4		<b>11 IR B 14 W</b>	0.8	0.9
19	16	3/8	<b>16 ER B 19 W</b>	<b>16 IR B 19 W</b>	0.8	1.0
16	16	3/8	<b>16 ER B 16 W</b>	<b>16 IR B 16 W</b>	0.9	1.1
14	16	3/8	<b>16 ER B 14 W</b>	<b>16 IR B 14 W</b>	1.0	1.2
11	16	3/8	<b>16 ER B 11 W</b>	<b>16 IR B 11 W</b>	1.1	1.5
10	16	3/8	<b>16 ER B 10 W</b>	<b>16 IR B 10 W</b>	1.1	1.5

Order example: 16 IR B 10 W BMA

### Vertical

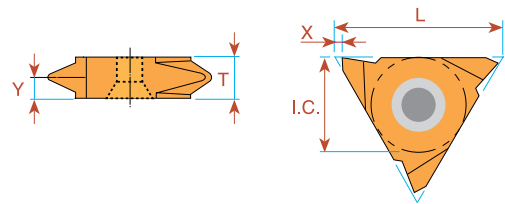

Pitch TPI	L	I.C. in	<b>EXTERNAL</b>	<b>EXTERNAL</b>	X	Y	T
			Ordering Code Right Hand	Ordering Code Left Hand			
20	16	3/8	<b>16V ER 20 W</b>	<b>16V EL 20 W</b>	1.0	0.9	3.6
19	16	3/8	<b>16V ER 19 W</b>	<b>16V EL 19 W</b>	1.0	0.9	3.6
18	16	3/8	<b>16V ER 18 W</b>	<b>16V EL 18 W</b>	1.0	1.0	3.6
16	16	3/8	<b>16V ER 16 W</b>	<b>16V EL 16 W</b>	1.0	1.0	3.6
14	16	3/8	<b>16V ER 14 W</b>	<b>16V EL 14 W</b>	1.0	1.2	3.6
12	16	3/8	<b>16V ER 12 W</b>	<b>16V EL 12 W</b>	1.0	1.4	3.6
11	16	3/8	<b>16V ER 11 W</b>	<b>16V EL 11 W</b>	1.0	1.5	3.6

Order example: 16V ER 14 W MXC

## Multitooth

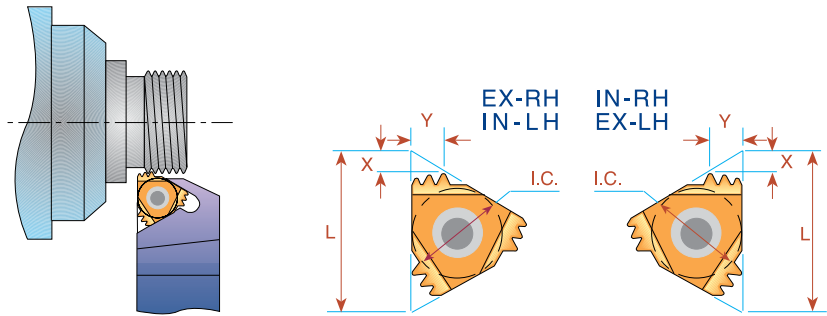

Pitch TPI	L	I.C. in	Number of Teeth	<b>EXTERNAL</b>		<b>INTERNAL</b>		X	Y
				Ordering Code	Anvil	Ordering Code	Anvil		
14	16	3/8	2	<b>16 ER 14 W 2M</b>	AE16M	<b>16 IR 14 W 2M</b>	AI16M	1.7	2.7
14	22	1/2	3	<b>22 ER 14 W 3M</b>	AE22M	<b>22 IR 14 W 3M</b>	AI22M	2.8	4.5
11	22	1/2	2	<b>22 ER 11 W 2M</b>	AE22M	<b>22 IR 11 W 2M</b>	AI22M	2.3	3.4

Order example: 16 ER 14 W 2M MXC

For recommended number of passes see page A04-4

## NPT

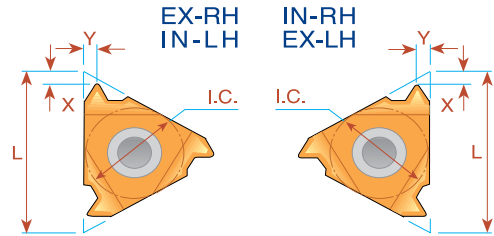
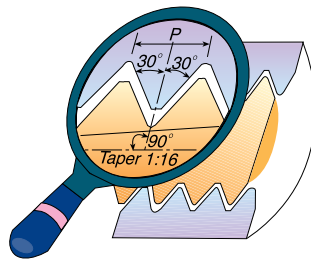

Pitch TPI	L	I.C. in	<b>EXTERNAL</b>		<b>INTERNAL</b>		X	Y
			Ordering Code Right Hand	Ordering Code Left Hand	Ordering Code Right Hand	Ordering Code Left Hand		
27	6	5/32	ULTRA MINIATURE →		*06 IR 27 NPT	*06 IL 27 NPT	0.6	0.6
27	8	3/16			*08 IR 27 NPT	*08 IL 27 NPT	0.6	0.6
18	8	3/16	MINIATURE →		*08 IR 18 NPT	*08 IL 18 NPT	0.6	0.6
27	11	1/4	11 ER 27 NPT	11 EL 27 NPT	11 IR 27 NPT	11 IL 27 NPT	0.7	0.8
18	11	1/4	11 ER 18 NPT	11 EL 18 NPT	11 IR 18 NPT	11 IL 18 NPT	0.8	1.0
14	11	1/4	11 ER 14 NPT	11 EL 14 NPT	11 IR 14 NPT	11 IL 14 NPT	0.8	1.0
27	16	3/8	16 ER 27 NPT	16 EL 27 NPT	16 IR 27 NPT	16 IL 27 NPT	0.7	0.8
18	16	3/8	16 ER 18 NPT	16 EL 18 NPT	16 IR 18 NPT	16 IL 18 NPT	0.8	1.0
14	16	3/8	16 ER 14 NPT	16 EL 14 NPT	16 IR 14 NPT	16 IL 14 NPT	0.9	1.2
11.5	16	3/8	16 ER 11.5 NPT	16 EL 11.5 NPT	16 IR 11.5 NPT	16 IL 11.5 NPT	1.1	1.5
8	16	3/8	16 ER 8 NPT	16 EL 8 NPT	16 IR 8 NPT	16 IL 8 NPT	1.3	1.8

\* Available only in BXC and BMA grades

Order example: 16 ER 14 NPT MXC

For small bore threading see page A06-16

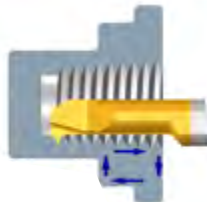

## Type B

Ground profile with sintered chip-breaker

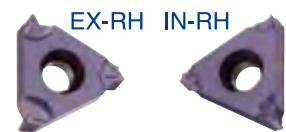

Pitch TPI	L	I.C. in	<b>EXTERNAL</b>		<b>INTERNAL</b>		X	Y
			Ordering Code Right Hand	Ordering Code Right Hand	Ordering Code Right Hand	Ordering Code Right Hand		
18	11	1/4			11 IR B 18 NPT		0.8	0.9
18	16	3/8	16 ER B 18 NPT		16 IR B 18 NPT		0.8	1.0
14	16	3/8	16 ER B 14 NPT		16 IR B 14 NPT		0.9	1.2
11.5	16	3/8	16 ER B 11.5 NPT		16 IR B 11.5 NPT		1.1	1.5
8	16	3/8	16 ER B 8 NPT		16 IR B 8 NPT		1.3	1.8

Order example: 16 IR B 11.5 NPT BMA

For carbide grade and cutting speed see page A04-2 and 3

## NPT Multitooth

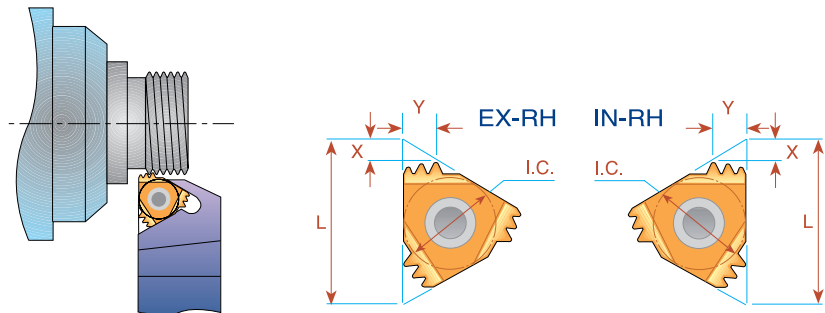

Pitch TPI	L	I.C. in	Number of Teeth	<b>EXTERNAL</b>		Anvil	<b>INTERNAL</b>		Anvil	X	Y
				Ordering Code	Ordering Code		Ordering Code	Ordering Code			
14	16	3/8	2	<b>16 ER 14 NPT 2M</b>	<b>16 IR 14 NPT 2M</b>	AE16M	<b>16 IR 14 NPT 2M</b>	AI16M	1.7	2.8	
11.5	22	1/2	2	<b>22 ER 11.5 NPT 2M</b>	<b>22 IR 11.5 NPT 2M</b>	AE22M	<b>22 IR 11.5 NPT 2M</b>	AI22M	2.3	3.5	
11.5	27	5/8	3	<b>27 ER 11.5 NPT 3M</b>	<b>27 IR 11.5 NPT 3M</b>	AE27M	<b>27 IR 11.5 NPT 3M</b>	AI27M	3.3	5.5	
8	27	5/8	2	<b>27 ER 8 NPT 2M</b>	<b>27 IR 8 NPT 2M</b>	AE27M	<b>27 IR 8 NPT 2M</b>	AI27M	3.1	5.0	

Order example: 22 ER 11.5 NPT 2M MXC

For recommended number of passes see page A04-4

## NPT Vertical

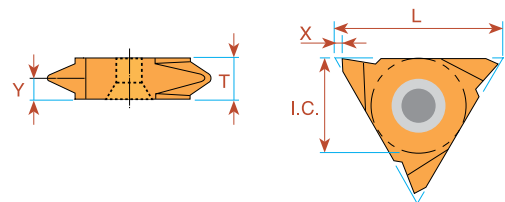

Pitch TPI	L	I.C. in	<b>EXTERNAL</b>		X	Y	T
			Ordering Code Right Hand	Ordering Code Left Hand			
27	16	3/8	<b>16V ER 27 NPT</b>	<b>16V EL 27 NPT</b>	1.0	0.8	3.6
18	16	3/8	<b>16V ER 18 NPT</b>	<b>16V EL 18 NPT</b>	1.0	1.0	3.6
14	16	3/8	<b>16V ER 14 NPT</b>	<b>16V EL 14 NPT</b>	1.0	1.2	3.6
11.5	16	3/8	<b>16V ER 11.5 NPT</b>	<b>16V EL 11.5 NPT</b>	1.0	1.5	3.6

Order example: 16V ER 14 NPT BMA

For carbide grade and cutting speed see page A04-2 and 3

## NPTF - Dryseal

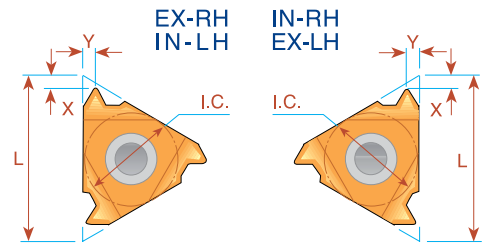
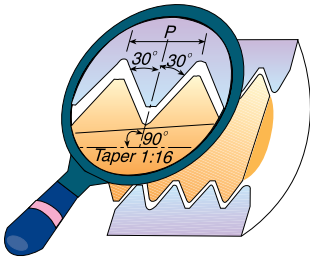

Pitch TPI	L	I.C. in	<b>EXTERNAL</b>		<b>INTERNAL</b>		X	Y
			Ordering Code Right Hand	Ordering Code Left Hand	Ordering Code Right Hand	Ordering Code Left Hand		
27	6	5/32	<i>ULTRA MINIATURE</i> →		*06 IR 27 NPTF	*06 IL 27 NPTF	0.7	0.6
27	8	3/16			*08 IR 27 NPTF	*08 IL 27 NPTF	0.6	0.6
18	8	3/16	<i>MINIATURE</i> →		*08 IR 18 NPTF	*08 IL 18 NPTF	0.6	0.6
27	11	1/4	11 ER 27 NPTF	11 EL 27 NPTF	11 IR 27 NPTF	11 IL 27 NPTF	0.7	0.7
18	11	1/4	11 ER 18 NPTF	11 EL 18 NPTF	11 IR 18 NPTF	11 IL 18 NPTF	0.8	1.0
14	11	1/4	11 ER 14 NPTF	11 EL 14 NPTF	11 IR 14 NPTF	11 IL 14 NPTF	0.8	1.0
27	16	3/8	16 ER 27 NPTF	16 EL 27 NPTF	16 IR 27 NPTF	16 IL 27 NPTF	0.7	0.7
18	16	3/8	16 ER 18 NPTF	16 EL 18 NPTF	16 IR 18 NPTF	16 IL 18 NPTF	0.8	1.0
14	16	3/8	16 ER 14 NPTF	16 EL 14 NPTF	16 IR 14 NPTF	16 IL 14 NPTF	0.9	1.2
11.5	16	3/8	16 ER 11.5 NPTF	16 EL 11.5 NPTF	16 IR 11.5 NPTF	16 IL 11.5 NPTF	1.1	1.5
8	16	3/8	16 ER 8 NPTF	16 EL 8 NPTF	16 IR 8 NPTF	16 IL 8 NPTF	1.3	1.8

\* Available only in BXC and BMA grades

Order example: 11 ER 27 NPTF MXC

## Type B

Ground profile with sintered chip-breaker

Pitch TPI	L	I.C. in	<b>INTERNAL</b> Ordering Code Right Hand	X	Y
18	11	1/4	11 IR B 18 NPTF	0.8	0.9

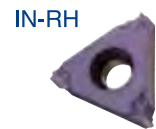

Order example: 11 IR B 18 NPTF BMA

## Multitooth

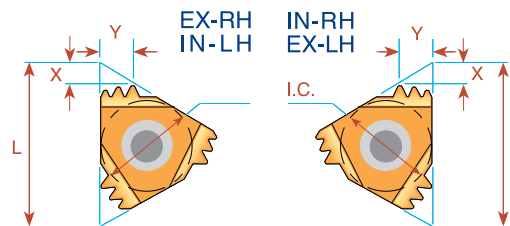
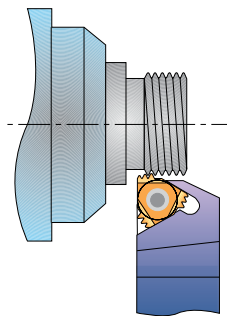

Pitch TPI	L	I.C. in	Number of Teeth	<b>EXTERNAL</b> Ordering Code	Anvil	<b>INTERNAL</b> Ordering Code	Anvil	X	Y
11.5	22	1/2	2	22 ER 11.5 NPTF 2M	AE22M	22 IR 11.5 NPTF 2M	AI22M	2.3	3.5

Order example: 22 ER 11.5 NPTF 2M BMA

For carbide grade and cutting speed see page A04-2 and 3

## BSPT

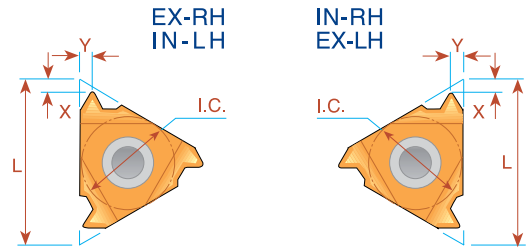
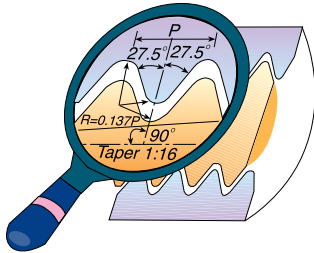

Pitch TPI	L	I.C. in	<b>EXTERNAL</b>		<b>INTERNAL</b>		X	Y
			Ordering Code Right Hand	Ordering Code Left Hand	Ordering Code Right Hand	Ordering Code Left Hand		
28	6	5/32	<i>ULTRA MINIATURE</i> →		*06 IR 28 BSPT	*06 IL 28 BSPT	0.7	0.6
28	8	3/16			*08 IR 28 BSPT	*08 IL 28 BSPT	0.6	0.6
19	8	3/16	<i>MINIATURE</i> →		*08 IR 19 BSPT	*08 IL 19 BSPT	0.6	0.6
28	11	1/4			11 IR 28 BSPT	11 IL 28 BSPT	0.6	0.6
19	11	1/4			11 IR 19 BSPT	11 IL 19 BSPT	0.8	0.9
14	11	1/4			11 IR 14 BSPT	11 IL 14 BSPT	0.9	1.0
11	11	1/4			<sup>(1)</sup> 11 IR 11 BSPT	<sup>(1)</sup> 11 IL 11 BSPT	0.9	1.2
28	16	3/8	16 ER 28 BSPT	16 EL 28 BSPT	16 IR 28 BSPT	16 IL 28 BSPT	0.6	0.6
19	16	3/8	16 ER 19 BSPT	16 EL 19 BSPT	16 IR 19 BSPT	16 IL 19 BSPT	0.8	0.9
14	16	3/8	16 ER 14 BSPT	16 EL 14 BSPT	16 IR 14 BSPT	16 IL 14 BSPT	1.0	1.2
11	16	3/8	16 ER 11 BSPT	16 EL 11 BSPT	16 IR 11 BSPT	16 IL 11 BSPT	1.1	1.5

\* Available only in BXC and BMA grades

Order example: 11 IR 14 BSPT BMA

(1) Special holder is required or standard holder can be amended by customer.

## Type B

Ground profile with sintered chip-breaker

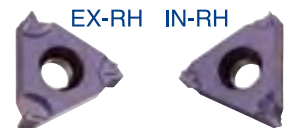

Pitch TPI	L	I.C. in	<b>EXTERNAL</b>		<b>INTERNAL</b>		X	Y
			Ordering Code Right Hand	Ordering Code Right Hand	Ordering Code Right Hand	Ordering Code Right Hand		
19	11	1/4			11 IR B 19 BSPT		0.8	0.9
19	16	3/8	16 ER B 19 BSPT				1.0	1.1
14	16	3/8	16 ER B 14 BSPT		16 IR B 14 BSPT		1.2	1.0
11	16	3/8	16 ER B 11 BSPT		16 IR B 11 BSPT		1.5	1.1

Order example: 16 ER B 11BSPT BMA

## BSPT Vertical

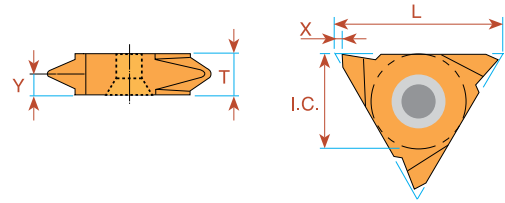

Pitch TPI	L	I.C. in	<b>EXTERNAL</b>	<b>EXTERNAL</b>	X	Y	T
			Ordering Code Right Hand	Ordering Code Left Hand			
28	16	3/8	<b>16V ER 28 BSPT</b>	<b>16V EL 28 BSPT</b>	1.0	0.6	3.6
19	16	3/8	<b>16V ER 19 BSPT</b>	<b>16V EL 19 BSPT</b>	1.0	0.9	3.6
14	16	3/8	<b>16V ER 14 BSPT</b>	<b>16V EL 14 BSPT</b>	1.0	1.2	3.6
11	16	3/8	<b>16V ER 11 BSPT</b>	<b>16V EL 11 BSPT</b>	1.0	1.5	3.6

Order example: 16V ER 19 BSPT BMA

## DIN 477

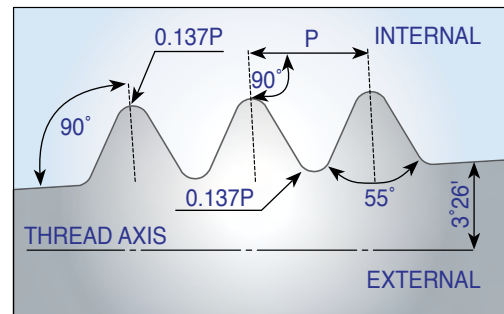

Pitch TPI	L	I.C. in	Taper Ratio	<b>EXTERNAL</b>	<b>INTERNAL</b>	X	Y	Thread Designation
				Ordering Code Right Hand	Ordering Code Right Hand			
14	16	3/8	3/25	<b>16 ER 14 DIN477</b>		1.0	1.2	W19.8x1/14 keg(Ext.)
14	11	1/4	3/25		<b>*11 IR 14 DIN477</b>	0.9	1.0	W19.8x1/14 keg(Int.)
14	16	3/8	3/25	<b>16 ER 14 DIN477</b>	<b>**16 IR 14 DIN477</b>	1.0	1.2	W28.8x1/14 keg
14	16	3/8	3/25	<b>16 ER 14 DIN477</b>	<b>***16 IR 14 DIN477</b>	1.0	1.2	W31.3x1/14 keg

\* Holder to use: SIR0010H11/SIR0010K11

\*\* Holder to use: SIR0016P16

\*\*\* Holder to use: SIR0020P16

Order example: 16 IR 14 DIN477 BMA

For carbide grade and cutting speed see page A04-2 and 3



## Acme

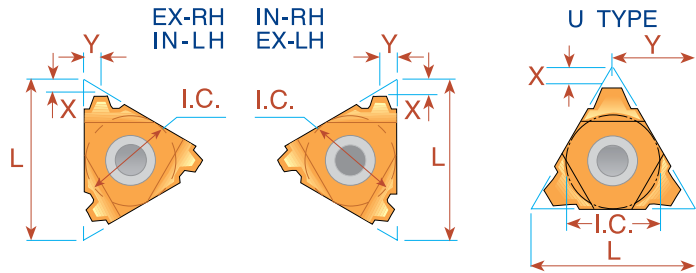
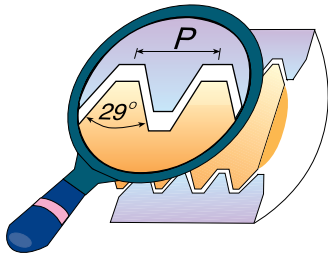

Pitch TPI	L	I.C. in	EXTERNAL		INTERNAL		X	Y
			Right Hand	Left Hand	Right Hand	Left Hand		
16	8	3/16	Ordering Code		Ordering Code			
			Right Hand	Left Hand	Right Hand	Left Hand		
16	8	3/16	MINIATURE →		**08 IR 16 ACME	**08 IL 16 ACME	0.6	0.6
14	8U	3/16U	"U" MINIATURE →		*08U IR/L 14 ACME		0.8	4.0
12	8U	3/16U			*08U IR/L 12 ACME		0.8	4.0
10	8U	3/16U			*08U IR/L 10 ACME		0.8	4.0
16	11	1/4	11 ER 16 ACME	11 EL 16 ACME	11 IR 16 ACME	11 IL 16 ACME	0.9	1.0
16	16	3/8	16 ER 16 ACME	16 EL 16 ACME	16 IR 16 ACME	16 IL 16 ACME	0.9	1.0
14	16	3/8	16 ER 14 ACME	16 EL 14 ACME	16 IR 14 ACME	16 IL 14 ACME	1.0	1.2
12	16	3/8	16 ER 12 ACME	16 EL 12 ACME	16 IR 12 ACME	16 IL 12 ACME	1.1	1.2
10	16	3/8	16 ER 10 ACME	16 EL 10 ACME	16 IR 10 ACME	16 IL 10 ACME	1.3	1.3
8	16	3/8	16 ER 8 ACME	16 EL 8 ACME	16 IR 8 ACME	16 IL 8 ACME	1.5	1.5
6	16	3/8	(1) 16 ER 6 ACME	(1) 16 EL 6 ACME	(1) 16 IR 6 ACME	(1) 16 IL 6 ACME	1.7	1.8
6	22	1/2	22 ER 6 ACME	22 EL 6 ACME	22 IR 6 ACME	22 IL 6 ACME	1.8	2.1
5	22	1/2	22 ER 5 ACME	22 EL 5 ACME	22 IR 5 ACME	22 IL 5 ACME	2.0	2.3
4	22	1/2	(1) 22 ER 4 ACME	(1) 22 EL 4 ACME	(1) 22 IR 4 ACME	(1) 22 IL 4 ACME	2.1	2.2
4	22U	1/2U	22U ER/L 4 ACME		22U IR/L 4 ACME		2.3	11.0
4	27	5/8	27 ER 4 ACME	27 EL 4 ACME	27 IR 4 ACME	27 IL 4 ACME	2.3	2.7
3	27U	5/8U	27U ER/L 3 ACME		27U IR/L 3 ACME		2.8	13.7
2	33U	3/4U	33U ER/L 2 ACME		33U IR/L 2 ACME		4.3	16.9

\* Available only in BXC and BMA grades

\*\* One cutting edge

Order example: 16 ER 16 ACME MXC

(1) Special holder is required or standard holder can be amended by customer.

## Acme Vertical

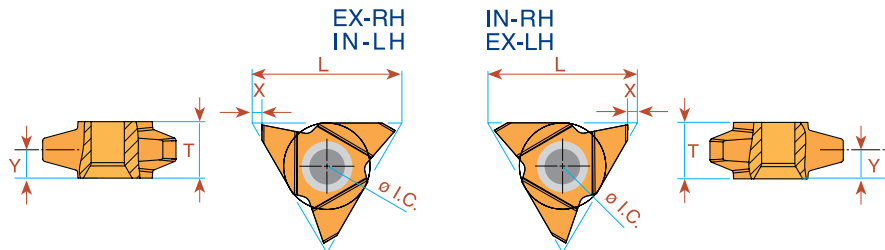

Pitch TPI	L	I.C. in	EXTERNAL		X	Y	T	INTERNAL		X	Y	T
			Right Hand	Left Hand				Right Hand	Left Hand			
* 3.5	27	5/8	27V ER 3.5 ACME	_____	1.8	5.0	10.4	27V IR 3.5 ACME	_____	1.8	4.0	10.4
* 3	27	5/8	27V ER 3 ACME	_____	1.8	5.0	10.4	27V IR 3 ACME	_____	1.8	4.6	10.4
** 2	27	5/8	27V ER 2 ACME	27V EL 2 ACME	1.8	5.0	10.4	27V IR 2 ACME	27V IL 2 ACME	1.8	5.0	10.4

\* Minimum bore: Ø55 mm \*\* Minimum bore: Ø76 mm

Order example: 27V ER 2 ACME BMA

For carbide grade and cutting speed see page A04-2 and 3

## Stub Acme

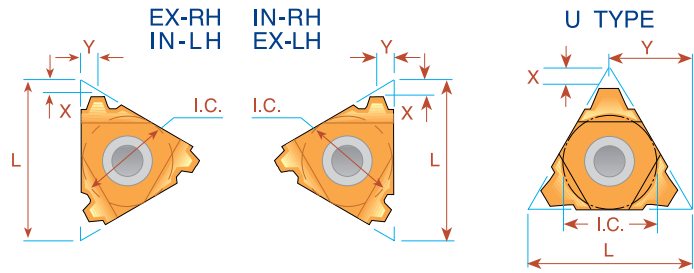
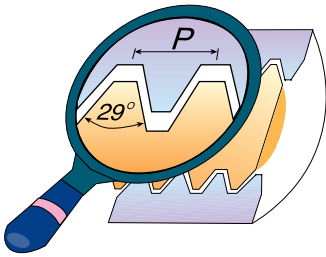

Pitch TPI	L	I.C. in	<b>EXTERNAL</b>		<b>INTERNAL</b>		X	Y
			Ordering Code		Ordering Code			
			Right Hand	Left Hand	Right Hand	Left Hand		
16	8	3/16	<i>MINIATURE</i> →		<b>**08 IR 16 STACME</b>	<b>**08 IL 16 STACME</b>	0.6	0.6
14	8U	3/16U	<i>"U" MINIATURE</i> →		<b>*08U IR/L 14 STACME</b>		0.8	4.0
12	8U	3/16U			<b>*08U IR/L 12 STACME</b>		0.9	4.0
10	8U	3/16U			<b>*08U IR/L 10 STACME</b>		1.0	4.0
16	11	1/4	<b>11 ER 16 STACME</b>	<b>11 EL 16 STACME</b>			1.0	1.0
16	16	3/8	<b>16 ER 16 STACME</b>	<b>16 EL 16 STACME</b>	<b>16 IR 16 STACME</b>	<b>16 IL 16 STACME</b>	1.0	1.0
14	16	3/8	<b>16 ER 14 STACME</b>	<b>16 EL 14 STACME</b>	<b>16 IR 14 STACME</b>	<b>16 IL 14 STACME</b>	1.1	1.1
12	16	3/8	<b>16 ER 12 STACME</b>	<b>16 EL 12 STACME</b>	<b>16 IR 12 STACME</b>	<b>16 IL 12 STACME</b>	1.2	1.2
10	16	3/8	<b>16 ER 10 STACME</b>	<b>16 EL 10 STACME</b>	<b>16 IR 10 STACME</b>	<b>16 IL 10 STACME</b>	1.3	1.3
8	16	3/8	<b>16 ER 8 STACME</b>	<b>16 EL 8 STACME</b>	<b>16 IR 8 STACME</b>	<b>16 IL 8 STACME</b>	1.5	1.5
6	16	3/8	<b>16 ER 6 STACME</b>	<b>16 EL 6 STACME</b>	<b>16 IR 6 STACME</b>	<b>16 IL 6 STACME</b>	1.8	1.8
6	22	1/2	<b>22 ER 6 STACME</b>	<b>22 EL 6 STACME</b>	<b>22 IR 6 STACME</b>	<b>22 IL 6 STACME</b>	1.8	1.8
5	22	1/2	<b>22 ER 5 STACME</b>	<b>22 EL 5 STACME</b>	<b>22 IR 5 STACME</b>	<b>22 IL 5 STACME</b>	2.0	2.3
4	22	1/2	<b>22 ER 4 STACME</b>	<b>22 EL 4 STACME</b>	<b>22 IR 4 STACME</b>	<b>22 IL 4 STACME</b>	2.3	2.4
4	22U	1/2U	<b>22U ER/L 4 STACME</b>		<b>22U IR/L 4 STACME</b>		2.5	11.0
3	22U	1/2U	<b>22U ER/L 3 STACME</b>		<b>22U IR/L 3 STACME</b>		3.3	11.0
4	27	5/8	<b>27 ER 4 STACME</b>	<b>27 EL 4 STACME</b>	<b>27 IR 4 STACME</b>	<b>27 IL 4 STACME</b>	2.3	2.4
3	27	5/8	<b>27 ER 3 STACME</b>	<b>27 EL 3 STACME</b>	<b>27 IR 3 STACME</b>	<b>27 IL 3 STACME</b>	2.8	2.9
2	33U	3/4U	<b>33U ER/L 2 STACME</b>		<b>33U IR/L 2 STACME</b>		5.0	16.9

\* Available only in BXC and BMA grades

\*\* One cutting edge

Order example: 22 IR 5 STACME MXC

## Trapez - DIN 103

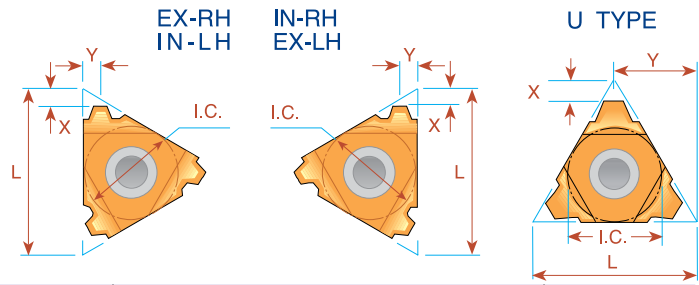
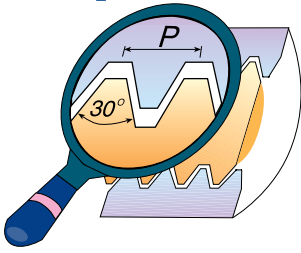

Pitch mm	L	I.C. in	<b>EXTERNAL</b> Ordering Code		<b>INTERNAL</b> Ordering Code		X	Y
			Right Hand	Left Hand	Right Hand	Left Hand		
1.5	8	3/16	MINIATURE →		**08 IR 1.5 TR	**08 IL 1.5 TR	0.6	0.6
2.0	8U	3/16U	"U" MINIATURE →		*08U IR/L 2 TR		0.9	4.0
1.5	16	3/8	16 ER 1.5 TR	16 EL 1.5 TR	16 IR 2 TR	16 IL 2 TR	1.0	1.1
2.0	16	3/8	16 ER 2 TR	16 EL 2 TR			1.0	1.3
3.0	16	3/8	16 ER 3 TR	16 EL 3 TR	16 IR 3 TR	16 IL 3 TR	1.3	1.5
4.0	16	3/8	(1) 16 ER 4 TR	(1) 16 EL 4 TR	(2) 16 IR 4 TR	(2) 16 IL 4 TR	1.3	1.5
5.0	16U	3/8U			***16U IR/L 5 TR		2.3	8.2
4.0	22	1/2	22 ER 4 TR	22 EL 4 TR	22 IR 4 TR	22 IL 4 TR	1.8	1.9
5.0	22	1/2	22 ER 5 TR	22 EL 5 TR	22 IR 5 TR	22 IL 5 TR	2.0	2.4
6.0	22	1/2	(1) 22 ER 6 TR	(1) 22 EL 6 TR	(1) 22 IR 6 TR	(1) 22 IL 6 TR	2.0	2.4
6.0	22U	1/2U	22U ER/L 6 TR		22U IR/L 6 TR		2.0	11.0
7.0	22U	1/2U	22U ER/L 7 TR		22U IR/L 7 TR		2.3	11.0
(3) 7.0	22U	1/2U			(3) 22U IR/L 7 TR40		2.6	11.0
8.0	22U	1/2U	22U ER/L 8 TR		22U IR/L 8 TR		2.5	11.0
6.0	27	5/8	27 ER 6 TR	27 EL 6 TR	27 IR 6 TR	27 IL 6 TR	2.3	2.7
7.0	27	5/8	27 ER 7 TR	27 EL 7 TR	27 IR 7 TR	27 IL 7 TR	2.2	2.6
8.0	27U	5/8U	27U ER/L 8 TR		27U IR/L 8 TR		2.5	13.7
9.0	27U	5/8U	27U ER/L 9 TR		27U IR/L 9 TR		3.0	13.7
10.0	27U	5/8U	**27U ER/L 10 TR		**27U IR/L 10 TR		3.2	13.7
12.0	33U	3/4U	33U ER/L 12 TR		33U IR/L 12 TR		3.9	16.9

\* Available only in BXC and BMA grades

\*\* One cutting edge

\*\*\* To be used only with holder SIR/L0014M16UB on page A02-10

Order example: 22 IR 5 TR MXC

(1) Special holder is required or standard holder can be amended by customer.

(2) Special holder is required or standard holder can be amended by customer or to be used with holders: SIR/L0012L16B; SIR/L0014L16B

(3) Only for Tr 40 x 7.0. To be used only with holder SIR/L0025S22UB

## Trapez - DIN 103 Vertical

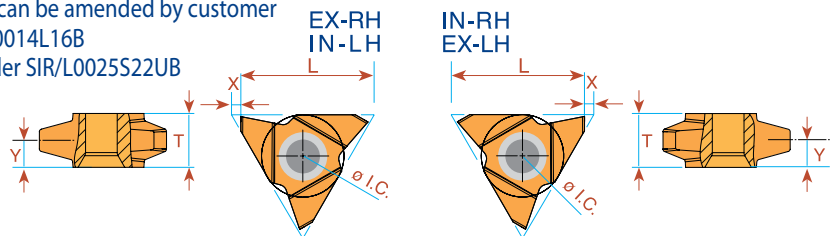

Pitch mm	L	I.C. in	<b>EXTERNAL</b> Ordering Code		<b>INTERNAL</b> Ordering Code		X	Y	T
			Right Hand	Left Hand	Right Hand	Left Hand			
* 9	27	5/8	27V ER 9 TR	27V EL 9 TR	27V IR 9 TR	27V IL 9 TR	1.8	5.2	10.4
* 10	27	5/8	27V ER 10 TR	27V EL 10 TR	27V IR 10 TR	27V IL 10 TR	1.8	5.2	10.4
** 12	27	5/8	27V ER 12 TR	27V EL 12 TR	27V IR 12 TR	27V IL 12 TR	1.8	5.2	10.4

\* Minimum bore: Ø65 mm \*\* Minimum bore: Ø73 mm

Order example: 27V ER 10 TR BMA

For carbide grade and cutting speed see page A04-2 and 3

## PG - DIN 40430

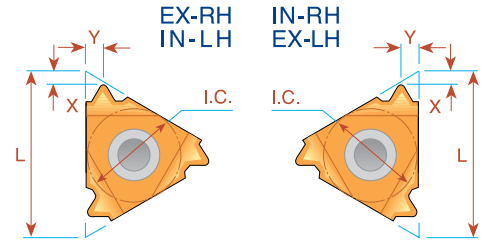
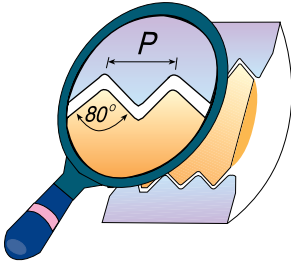

Pitch TPI	L	I.C. in	EXTERNAL		INTERNAL		X	Y
			Right Hand	Standard	Right Hand	Standard		
20	8	3/16	MINIATURE →		*08 IR 20 PG	(PG 7)	0.6	0.7
18	11	1/4			11 IR 18 PG	(PG 9)	0.8	0.9
20	16	3/8	16 ER 20 PG	(PG 7)	16 IR 18 PG	(PG 11, 13.5, 16)	0.7	0.8
18	16	3/8	16 ER 18 PG	(PG 9, 11, 13.5, 16)	16 IR 18 PG	(PG 11, 13.5, 16)	0.8	0.9
16	16	3/8	16 ER 16 PG	(PG 21, 29, 36, 42, 48)	16 IR 16 PG	(PG 21, 29, 36, 42, 48)	0.8	1.0

\* Available only in BXC and BMA grades

Order example: 16 ER 16 PG BMA

## Sagengewinde - DIN 513

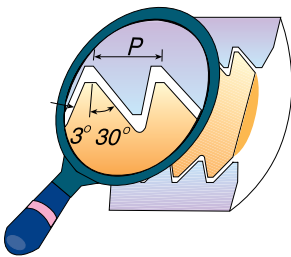

**IMPORTANT NOTE:**  
In Carmex standard execution, the flank with the large angle is the leading edge. If otherwise required, please specify in your order.

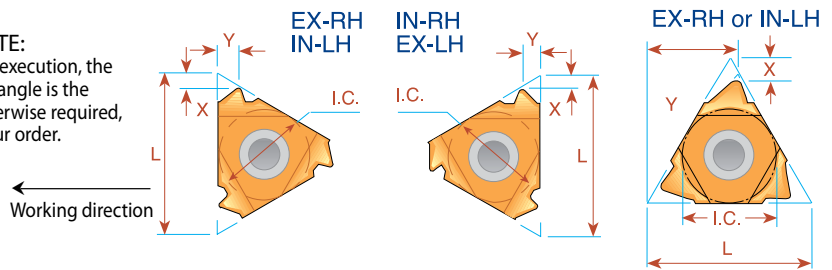

Pitch mm	L	I.C. in	EXTERNAL		X	Y	INTERNAL		X	Y
			Right Hand	Left Hand			Right Hand	Left Hand		
2.0	16	3/8	16 ER 2 SAGE	16 EL 2 SAGE	1.1	1.6	16 IR 2 SAGE	16 IL 2 SAGE	1.2	1.7
**3.0	22	1/2	22 ER 3 SAGE	22 EL 3 SAGE	1.5	2.4	22 IR 3 SAGE	22 IL 3 SAGE	1.9	2.9
**4.0	22	1/2	22 ER 4 SAGE	22 EL 4 SAGE	1.9	3.1	22 IR 4 SAGE	22 IL 4 SAGE	2.3	3.5
*5.0	22U	1/2U	22U ER 5 SAGE	22U EL 5 SAGE	1.2	11.6	22U IR 5 SAGE	22U IL 5 SAGE	1.9	11.7
*6.0	22U	1/2U	22U ER 6 SAGE	22U EL 6 SAGE	1.2	11.7	22U IR 6 SAGE	22U IL 6 SAGE	2.1	11.9

\* Requires a special anvil AER 22U-1.5 SAGE 5/6, AEL 22U-1.5 SAGE 5/6, AIR 22U-1.5 SAGE 5/6, AIL 22U-1.5 SAGE 5/6

\*\* Requires a special anvil AER 22-1.5 SAGE 3/4, AEL 22-1.5 SAGE 3/4, AIR 22-1.5 SAGE 3/4, AIL 22-1.5 SAGE 3/4

Order example: 22 IR 4 SAGE BMA

For carbide grade and cutting speed see page A04-2 and 3

## Round - DIN 405

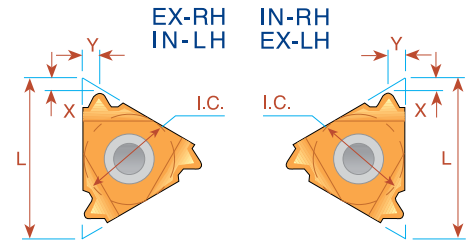
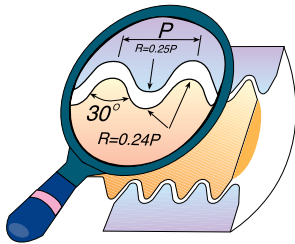

Pitch TPI	L	I.C. in	<b>EXTERNAL</b>		X	Y	<b>INTERNAL</b>		X	Y
			Right Hand	Left Hand			Right Hand	Left Hand		
10	16	3/8	16 ER 10 RD	16 EL 10 RD	1.1	1.2	16 IR 10 RD	16 IL 10 RD	1.1	1.2
8	16	3/8	16 ER 8 RD	16 EL 8 RD	1.4	1.3	16 IR 8 RD	16 IL 8 RD	1.4	1.4
6	16	3/8	16 ER 6 RD	16 EL 6 RD	1.5	1.7	16 IR 6 RD	16 IL 6 RD	1.4	1.5
6	22	1/2	22 ER 6 RD	22 EL 6 RD	1.5	1.7	22 IR 6 RD	22 IL 6 RD	1.5	1.7
4	22	1/2	22 ER 4 RD	22 EL 4 RD	2.2	2.3	22 IR 4 RD	22 IL 4 RD	2.2	2.3
4	27	5/8	27 ER 4 RD	27 EL 4 RD	2.2	2.3	27 IR 4 RD	27 IL 4 RD	2.2	2.3

Order example: 27 IL 4 RD BMA

## Round - DIN 20400

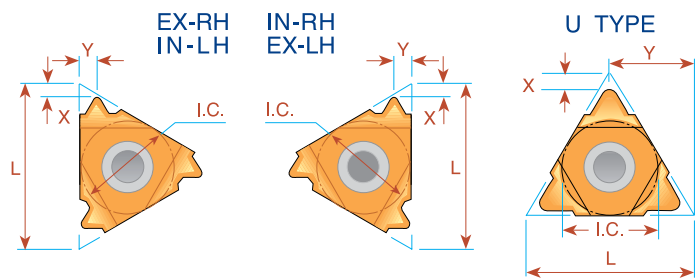
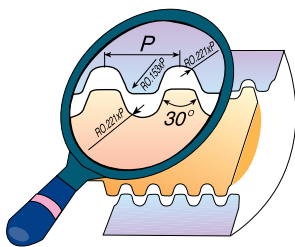

Pitch mm	L	I.C. in	<b>EXTERNAL</b>	<b>INTERNAL</b>	X	Y
			Ordering Code Right Hand	Ordering Code Right Hand		
4.0	22	1/2	22 ER 4.0 RD 20400	22 IR 4.0 RD 20400	1.4	1.4
5.0	22	1/2	22 ER 5.0 RD 20400	22 IR 5.0 RD 20400	1.7	1.8
6.0	22	1/2	22 ER 6.0 RD 20400	22 IR 6.0 RD 20400	1.7	2.0
8.0	27U	5/8U	*27U E/R/L 8.0 RD 20400		3.0	13.7
10.0	27U	5/8U	*27U E/R/L 10.0 RD 20400		3.4	13.7
12.0	33U	3/4U	*33U E/R/L 12.0 RD 20400		4.3	16.9

\* Same insert for Internal and External Right Hand Thread

Order example: 22 ER 4.0 RD 20400 MXC

For carbide grade and cutting speed see page A04-2 and 3

## UNJ UNJC, UNJF, UNJEF, UNJS

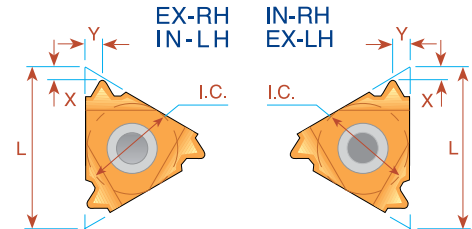
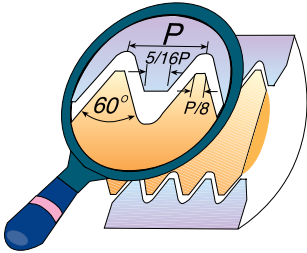

Pitch TPI	L	I.C. in	<b>EXTERNAL</b>		<b>INTERNAL</b>		X	Y
			Right Hand	Left Hand	Right Hand	Left Hand		
28	08	3/16			*08 IR 28 UNJ	*08 IL 28 UNJ	0.6	0.6
24	08	3/16	<i>MINIATURE</i> →		*08 IR 24 UNJ	*08 IL 24 UNJ	0.6	0.6
20	08	3/16			*08 IR 20 UNJ	*08 IL 20 UNJ	0.6	0.7
18	08	3/16			*08 IR 18 UNJ	*08 IL 18 UNJ	0.6	0.7
13	08U	3/16U			<i>"U" MINIATURE</i> →		*08 UIR/L 13 UNJ	
48	11	1/4	11 ER 48 UNJ	11 EL 48 UNJ	11 IR 48 UNJ	11 IL 48 UNJ	0.6	0.6
44	11	1/4	11 ER 44 UNJ	11 EL 44 UNJ	11 IR 44 UNJ	11 IL 44 UNJ	0.6	0.6
40	11	1/4	11 ER 40 UNJ	11 EL 40 UNJ	11 IR 40 UNJ	11 IL 40 UNJ	0.6	0.6
36	11	1/4	11 ER 36 UNJ	11 EL 36 UNJ	11 IR 36 UNJ	11 IL 36 UNJ	0.6	0.6
32	11	1/4	11 ER 32 UNJ	11 EL 32 UNJ	11 IR 32 UNJ	11 IL 32 UNJ	0.6	0.6
28	11	1/4	11 ER 28 UNJ	11 EL 28 UNJ	11 IR 28 UNJ	11 IL 28 UNJ	0.6	0.6
24	11	1/4	11 ER 24 UNJ	11 EL 24 UNJ	11 IR 24 UNJ	11 IL 24 UNJ	0.7	0.8
20	11	1/4	11 ER 20 UNJ	11 EL 20 UNJ	11 IR 20 UNJ	11 IL 20 UNJ	0.8	0.9
18	11	1/4	11 ER 18 UNJ	11 EL 18 UNJ	11 IR 18 UNJ	11 IL 18 UNJ	0.8	1.0
16	11	1/4	11 ER 16 UNJ	11 EL 16 UNJ	11 IR 16 UNJ	11 IL 16 UNJ	0.8	1.0
14	11	1/4	11 ER 14 UNJ	11 EL 14 UNJ	11 IR 14 UNJ	11 IL 14 UNJ	0.9	1.0
48	16	3/8	16 ER 48 UNJ	16 EL 48 UNJ	16 IR 48 UNJ	16 IL 48 UNJ	0.6	0.6
44	16	3/8	16 ER 44 UNJ	16 EL 44 UNJ	16 IR 44 UNJ	16 IL 44 UNJ	0.6	0.6
40	16	3/8	16 ER 40 UNJ	16 EL 40 UNJ	16 IR 40 UNJ	16 IL 40 UNJ	0.6	0.6
36	16	3/8	16 ER 36 UNJ	16 EL 36 UNJ	16 IR 36 UNJ	16 IL 36 UNJ	0.6	0.6
32	16	3/8	16 ER 32 UNJ	16 EL 32 UNJ	16 IR 32 UNJ	16 IL 32 UNJ	0.6	0.6
28	16	3/8	16 ER 28 UNJ	16 EL 28 UNJ	16 IR 28 UNJ	16 IL 28 UNJ	0.6	0.6
24	16	3/8	16 ER 24 UNJ	16 EL 24 UNJ	16 IR 24 UNJ	16 IL 24 UNJ	0.7	0.8
20	16	3/8	16 ER 20 UNJ	16 EL 20 UNJ	16 IR 20 UNJ	16 IL 20 UNJ	0.8	0.9
18	16	3/8	16 ER 18 UNJ	16 EL 18 UNJ	16 IR 18 UNJ	16 IL 18 UNJ	0.8	1.0
16	16	3/8	16 ER 16 UNJ	16 EL 16 UNJ	16 IR 16 UNJ	16 IL 16 UNJ	0.8	1.0
14	16	3/8	16 ER 14 UNJ	16 EL 14 UNJ	16 IR 14 UNJ	16 IL 14 UNJ	1.0	1.2
13	16	3/8	16 ER 13 UNJ	16 EL 13 UNJ	16 IR 13 UNJ	16 IL 13 UNJ	1.0	1.3
12	16	3/8	16 ER 12 UNJ	16 EL 12 UNJ	16 IR 12 UNJ	16 IL 12 UNJ	1.1	1.4
11	16	3/8	16 ER 11 UNJ	16 EL 11 UNJ	16 IR 11 UNJ	16 IL 11 UNJ	1.1	1.5
10	16	3/8	16 ER 10 UNJ	16 EL 10 UNJ	16 IR 10 UNJ	16 IL 10 UNJ	1.1	1.5
9	16	3/8	16 ER 9 UNJ	16 EL 9 UNJ	16 IR 9 UNJ	16 IL 9 UNJ	1.2	1.6
8	16	3/8	16 ER 8 UNJ	16 EL 8 UNJ	16 IR 8 UNJ	16 IL 8 UNJ	1.2	1.6

\* Available only in BXC and BMA grades  
Order example: 16 IR 16 UNJ MXC

For carbide grade and cutting speed see page A04-2 and 3

## UNJ UNJC, UNJF, UNJEF, UNJS

### Type B

Ground profile with sintered chip-breaker

Pitch TPI	L	I.C. in	<b>INTERNAL</b> Ordering Code Right Hand	X	Y
32	11	1/4	<b>11 IR B 32 UNJ</b>	0.6	0.6
28	11	1/4	<b>11 IR B 28 UNJ</b>	0.6	0.6
24	11	1/4	<b>11 IR B 24 UNJ</b>	0.6	0.6
20	11	1/4	<b>11 IR B 20 UNJ</b>	0.8	0.9
18	11	1/4	<b>11 IR B 18 UNJ</b>	0.8	0.9
16	11	1/4	<b>11 IR B 16 UNJ</b>	0.8	0.9
14	11	1/4	<b>11 IR B 14 UNJ</b>	0.8	0.9

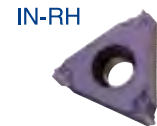

Order example: 11 IR B 20 UNJ BMA

### Multitooth

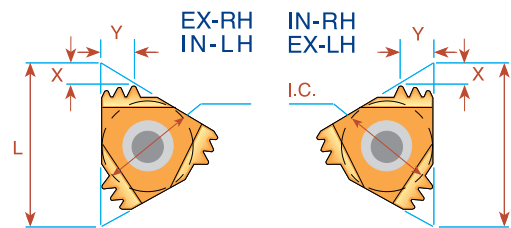
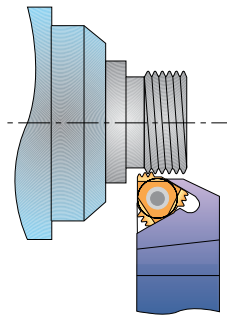

Pitch TPI	L	I.C. in	Number of Teeth	<b>EXTERNAL</b> Ordering Code	Anvil	<b>INTERNAL</b> Ordering Code	Anvil	X	Y
16	16	3/8	2	<b>16 ER 16 UNJ 2M</b>	AE16M	-	-	1.6	2.4
16	22	1/2	3	<b>22 ER 16 UNJ 3M</b>	AE22M	-	-	2.3	3.8

Order example: 22 ER 16 UNJ 3M BMA



## MJ - ISO 5855

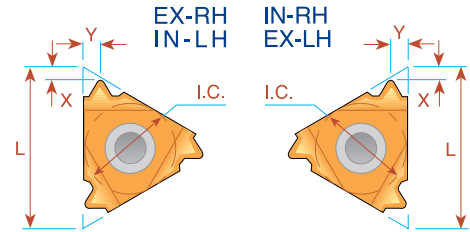
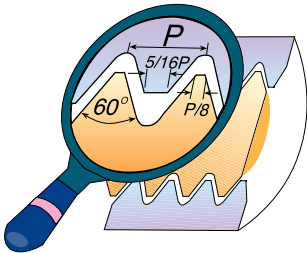

Pitch mm	L	I.C. in	<b>EXTERNAL</b>	<b>INTERNAL</b>	X	Y
			Ordering Code Right Hand	Ordering Code Right Hand		
0.5	11	1/4		<b>11 IR 0.5 MJ</b>	0.5	0.4
0.7	11	1/4		<b>11 IR 0.7 MJ</b>	0.6	0.5
0.75	11	1/4		<b>11 IR 0.75 MJ</b>	0.6	0.5
0.8	11	1/4		<b>11 IR 0.8 MJ</b>	0.6	0.6
1.0	11	1/4	<b>11 ER 1.0 MJ</b>	<b>11 IR 1.0 MJ</b>	0.7	0.8
1.25	11	1/4	<b>11 ER 1.25 MJ</b>	<b>11 IR 1.25 MJ</b>	0.8	0.9
1.5	11	1/4	<b>11 ER 1.5 MJ</b>	<b>11 IR 1.5 MJ</b>	0.8	1.0
2.0	11	1/4		<b>11 IR 2.0 MJ</b>	0.9	1.0
0.5	16	3/8	<b>16 ER 0.5 MJ</b>		0.6	0.6
0.7	16	3/8	<b>16 ER 0.7 MJ</b>		0.6	0.6
0.75	16	3/8	<b>16 ER 0.75 MJ</b>	<b>16 IR 0.75 MJ</b>	0.5	0.5
0.8	16	3/8	<b>16 ER 0.8 MJ</b>	<b>16 IR 0.8 MJ</b>	0.6	0.6
1.0	16	3/8	<b>16 ER 1.0 MJ</b>	<b>16 IR 1.0 MJ</b>	0.7	0.8
1.25	16	3/8	<b>16 ER 1.25 MJ</b>	<b>16 IR 1.25 MJ</b>	0.8	0.9
1.5	16	3/8	<b>16 ER 1.5 MJ</b>	<b>16 IR 1.5 MJ</b>	0.8	1.0
1.75	16	3/8	<b>16 ER 1.75 MJ</b>	<b>16 IR 1.75 MJ</b>	0.9	1.1
2.0	16	3/8	<b>16 ER 2.0 MJ</b>	<b>16 IR 2.0 MJ</b>	1.0	1.3
3.0	16	3/8	<b>16 ER 3.0 MJ</b>	<b>16 IR 3.0 MJ</b>	1.2	1.6

Order example: 16 ER 1.5 MJ BMA

## Type B

Ground profile with sintered chip-breaker

Pitch mm	L	I.C. in	<b>INTERNAL</b>	X	Y
			Ordering Code Right Hand		
1.0	11	1/4	<b>11 IR B 1.0 MJ</b>	0.6	0.6
1.5			<b>11 IR B 1.5 MJ</b>	0.8	0.9



Order example: 11 IR B 1.5 MJ BMA

For carbide grade and cutting speed see page A04-2 and 3

## American Buttress

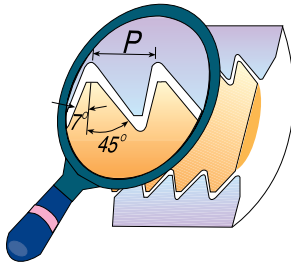

**IMPORTANT NOTE:**  
In Carmex standard execution, the flank with the large angle is the leading edge. If otherwise required, please specify in your order.

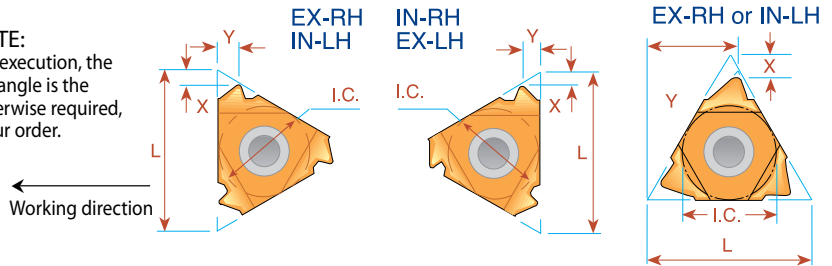

Pitch TPI	L	I.C. in	<b>EXTERNAL</b>		<b>INTERNAL</b>		X	Y
			Right Hand	Left Hand	Right Hand	Left Hand		
20	11	1/4	<b>11 ER 20 ABUT</b>	<b>11 EL 20 ABUT</b>	<b>11 IR 20 ABUT</b>	<b>11 IL 20 ABUT</b>	1.0	1.3
16	11	1/4	<b>11 ER 16 ABUT</b>	<b>11 EL 16 ABUT</b>	<b>11 IR 16 ABUT</b>	<b>11 IL 16 ABUT</b>	1.0	1.5
20	16	3/8	<b>16 ER 20 ABUT</b>	<b>16 EL 20 ABUT</b>	<b>16 IR 20 ABUT</b>	<b>16 IL 20 ABUT</b>	1.0	1.3
16	16	3/8	<b>16 ER 16 ABUT</b>	<b>16 EL 16 ABUT</b>	<b>16 IR 16 ABUT</b>	<b>16 IL 16 ABUT</b>	1.0	1.5
12	16	3/8	<b>16 ER 12 ABUT</b>	<b>16 EL 12 ABUT</b>	<b>16 IR 12 ABUT</b>	<b>16 IL 12 ABUT</b>	1.4	2.0
10	16	3/8	<b>16 ER 10 ABUT</b>	<b>16 EL 10 ABUT</b>	<b>16 IR 10 ABUT</b>	<b>16 IL 10 ABUT</b>	1.5	2.3
8	22	1/2	<b>22 ER 8 ABUT</b>	<b>22 EL 8 ABUT</b>	<b>22 IR 8 ABUT</b>	<b>22 IL 8 ABUT</b>	2.1	3.3
6	22	1/2	<b>22 ER 6 ABUT</b>	<b>22 EL 6 ABUT</b>	<b>22 IR 6 ABUT</b>	<b>22 IL 6 ABUT</b>	2.1	3.4
(1) 4	22U	1/2U	<b>22UER 4 ABUT</b>	<b>22UEL 4 ABUT</b>	<b>22UIR 4 ABUT</b>	<b>22UIL 4 ABUT</b>	2.3	9.5
(3) 5	27	5/8	<b>27 ER 5 ABUT</b>	<b>27 EL 5 ABUT</b>	<b>27 IR 5 ABUT</b>	<b>27 IL 5 ABUT</b>	2.75	4.5
(2) 3	27U	5/8U	<b>27UER 3 ABUT</b>	<b>27UEL 3 ABUT</b>	<b>27UIR 3 ABUT</b>	<b>27UIL 3 ABUT</b>	3.1	11.7

Order example: 16 IL 12 ABUT MXC

Most applications requires anvil change in toolholder see page A04-7

- (1) Requires a special anvil AE 22U-1.5 ABUT4, AI22U-1.5 ABUT4
- (2) Requires a special anvil AE 27U-1.5 ABUT3, AI27U-1.5 ABUT3
- (3) Requires a special anvil AE 27-1.5 ABUT5, AI27-1.5 ABUT5

## Multitooth

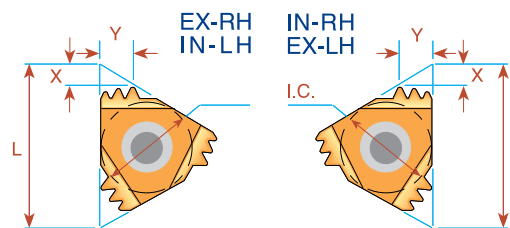
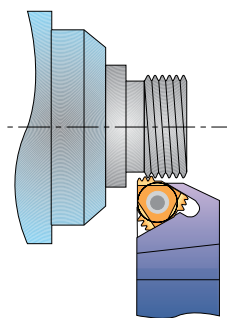

Pitch TPI	L	I.C. in	Number of Teeth	<b>EXTERNAL</b>	Anvil	<b>INTERNAL</b>	Anvil	X	Y
				Ordering Code		Ordering Code			
12	22	1/2	2	<b>22 ER 12 ABUT 2M</b>	AE22M	<b>22 IR 12 ABUT 2M</b>	AI22M	2.5	4.0

Order example: 22 IR 12 ABUT 2M BMA

For carbide grade and cutting speed see page A04-2 and 3

## Threading Tools for the Oil & Gas Industries

### API Round

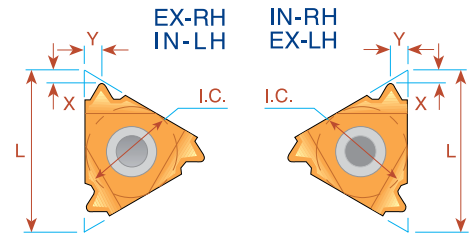
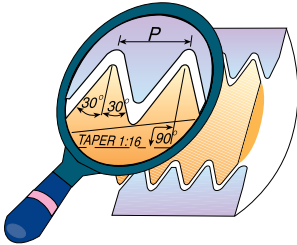

Pitch TPI	L	I.C. in	Taper IPF	<b>EXTERNAL</b> Ordering Code Right Hand	<b>INTERNAL</b> Ordering Code Right Hand	X	Y
10	16	3/8	0.75	<b>16 ER 10 API RD</b>	<b>16 IR 10 API RD</b>	1.5	1.4
8	16	3/8	0.75	<b>16 ER 8 API RD</b>	<b>16 IR 8 API RD</b>	1.3	1.6

Order example: 16 ER 10 API RD BMA

### Multitooth

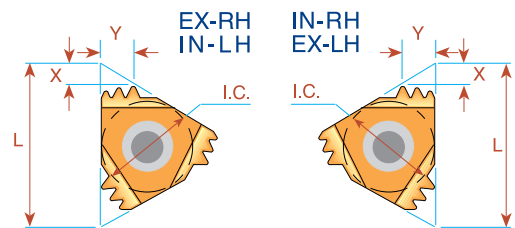
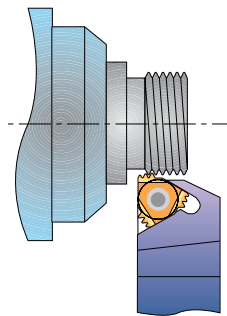

Pitch TPI	L	I.C. in	Number of Teeth	<b>EXTERNAL</b> Ordering Code	Anvil	<b>INTERNAL</b> Ordering Code	Anvil	X	Y
10	22	1/2	2	<b>22 ER 10API RD 2M</b>	AE22M	<b>22 IR 10API RD 2M</b>	AI22M	2.4	3.7
10	27	5/8	3	<b>27 ER 10API RD 3M</b>	AE27M	<b>27 IR 10API RD 3M</b>	AI27M	3.8	6.2
8	27	5/8	2	<b>27 ER 8API RD 2M</b>	AE27M	<b>27 IR 8API RD 2M</b>	AI27M	3.0	4.5

Order example: 27 IR 10 API RD 3M MXC

For recommended number of passes see page A04-4

For carbide grade and cutting speed see page A04-2 and 3

## OIL Threads

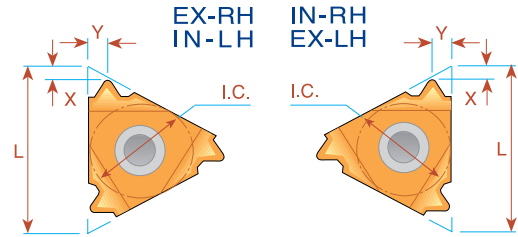
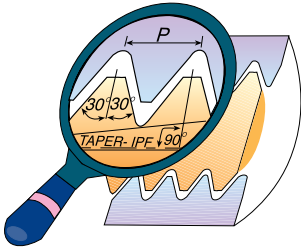

### V-0.040

Pitch TPI	L	I.C. in	Taper IPF	<b>EXTERNAL</b> Ordering Code Right Hand	<b>INTERNAL</b> Ordering Code Right Hand	X	Y	Connection No. or Size
5	22	1/2	3	<b>22 ER 5 API 403</b>	<b>22 IR 5 API 403</b>	1.8	2.5	23/8-4 1/2 REG

### (1) V-0.038R

Pitch TPI	L	I.C. in	Taper IPF	<b>EXTERNAL</b> Ordering Code Right Hand	<b>INTERNAL</b> Ordering Code Right Hand	X	Y	Connection No. or Size
4	27	5/8	2	<b>27 ER 4 API 382</b>	<b>27 IR 4 API 382</b>	2.1	2.8	NC23-NC50
4	27	5/8	3	<b>27 ER 4 API 383</b>	<b>27 IR 4 API 383</b>	2.1	2.8	NC56-NC77
4	22	1/2	2	<b>22 ER 4 API 382</b>	<b>22 IR 4 API 382</b>	2.0	2.5	NC23-NC50
4	22	1/2	3	<b>22 ER 4 API 383</b>	<b>22 IR 4 API 383</b>	2.0	2.6	NC56-NC77

Order example: 27 ER 4 API 383 MXC

### (1) V-0.050

Pitch TPI	L	I.C. in	Taper IPF	<b>EXTERNAL</b> Ordering Code Right Hand	<b>INTERNAL</b> Ordering Code Right Hand	X	Y	Connection No. or Size
4	27	5/8	2	<b>27 ER 4 API 502</b>	<b>27 IR 4 API 502</b>	2.0	3.0	65/8 REG
4	27	5/8	3	<b>27 ER 4 API 503</b>	<b>27 IR 4 API 503</b>	2.0	3.0	5 1/2, 75/8, 85/8 REG
4	22	1/2	2	<b>22 ER 4 API 502</b>	<b>22 IR 4 API 502</b>	1.9	2.7	65/8 REG
4	22	1/2	3	<b>22 ER 4 API 503</b>	<b>22 IR 4 API 503</b>	1.9	2.8	5 1/2, 75/8, 85/8 REG

Order example: 22 ER 4 API 502 BMA

### V-0.055

Macaroni Tubing (MT)

American Macaroni Tubing (AMT)

American Mining Macaroni Tubing (AMMT)

Pitch TPI	L	I.C. in	Taper IPF	<b>EXTERNAL</b> Ordering Code Right Hand	<b>INTERNAL</b> Ordering Code Right Hand	X	Y	Connection No. or Size
6	22	1/2	1.5	<b>22 ER 6 API 551.5</b>	-	2.0	1.7	NC10,NC12,NC13,NC16
6	16	3/8	1.5	-	<b>16 IR 6 API 551.5</b>	2.0	1.7	NC10,NC12,NC13 *
6	22	1/2	1.5	-	<b>22 IR 6 API 551.5</b>	2.0	1.7	NC16 **

\* For NC10,NC12 use holder SIR0016P16CB  
For NC13 use holders SIR0020P16/SIR0020P16B/SIR0020S16CB

\*\* For NC16 use holder SIR0025R22

(1) For V-0.038R, V-0.050 we recommend to use size 27 for more stability.

For carbide grade and cutting speed see page A04-2 and 3

## OIL Threads Extreme - Line Casing

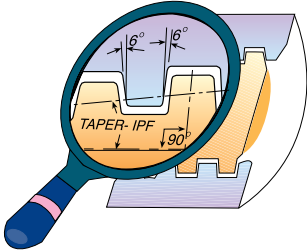

Pitch TPI	L	I.C. in	Taper IPF	<b>EXTERNAL</b>	<b>INTERNAL</b>	X	Y	Connection No. or Size
				Ordering Code Right Hand	Ordering Code Right Hand			
6	22	1/2	1.50	<b>22 ER 6 EL 1.5</b>	<b>22 IR 6 EL 1.5</b>	1.9	1.9	5 - 7 <sup>5</sup> / <sub>8</sub>
5	22	1/2	1.25	<b>22 ER 5 EL 1.25</b>	<b>22 IR 5 EL 1.25</b>	2.4	2.3	8 <sup>5</sup> / <sub>8</sub> -10 <sup>3</sup> / <sub>4</sub>

## Buttress Casing

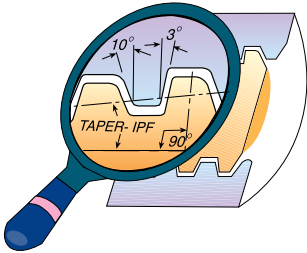

Pitch TPI	L	I.C. in	Taper IPF	<b>EXTERNAL</b>	<b>INTERNAL</b>	X	Y	Connection No. or Size
				Ordering Code Right Hand	Ordering Code Right Hand			
5	22	1/2	0.75	<b>22 ER 5 BUT 0.75</b>	<b>22 IR 5 BUT 0.75</b>	2.2	2.4	4 <sup>1</sup> / <sub>2</sub> -13 <sup>3</sup> / <sub>8</sub>
5	22	1/2	1.00	<b>22 ER 5 BUT 1.0</b>	<b>22 IR 5 BUT 1.0</b>	2.3	2.4	16 -20

Order example: 22 ER 5 BUT 0.75 MXC

## VAM

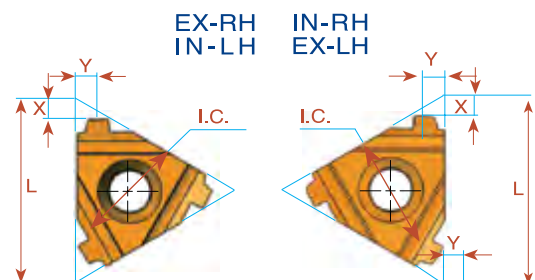
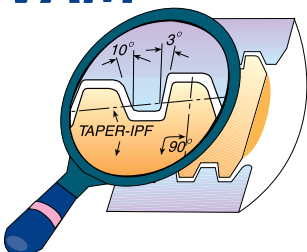

Pitch TPI	L	I.C. in	Taper IPF	<b>EXTERNAL</b>	X	Y	<b>INTERNAL</b>	X	Y	Connection No. or Size
				Ordering Code Right Hand			Ordering Code Right Hand			
8	16	3/8	0.75	<b>16 ER 8 VAM</b>	1.7	1.8	<b>16 IR 8 VAM</b>	1.7	1.8	2 <sup>3</sup> / <sub>8</sub> - 2 <sup>7</sup> / <sub>8</sub>
6	22	1/2	0.75	<b>22 ER 6 VAM</b>	2.4	2.4	<b>22 IR 6 VAM</b>	2.5	2.5	3 <sup>1</sup> / <sub>2</sub> - 4 <sup>1</sup> / <sub>2</sub>
5	22	1/2	0.75	<b>22 ER 5 VAM</b>	2.4	2.7	<b>22 IR 5 VAM</b>	2.4	2.5	5 - 13 <sup>3</sup> / <sub>8</sub>

Order example: 16 ER 8 VAM BMA

For carbide grade and cutting speed see page A04-2 and 3

## HUGHES

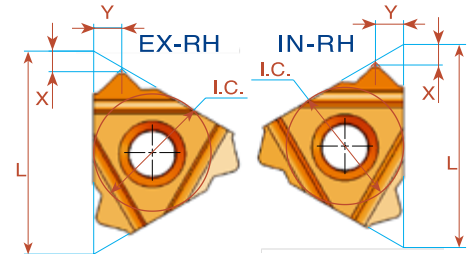
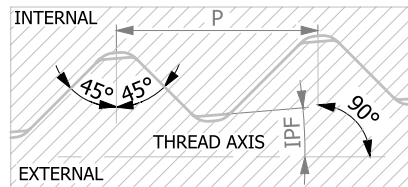

Pitch TPI	L mm	I.C.	Taper IPF	<b>EXTERNAL</b>	<b>INTERNAL</b>	X	Y	Connection No. or Size
				Ordering Code Right Hand	Ordering Code Right Hand			
3.5	27	5/8	2	<b>27 ER 3.5 H-902</b>	<b>27 IR 3.5 H-902</b>	2.8	3.8	31/2 - 65/8
3.5	27	5/8	3	<b>27 ER 3.5 H-903</b>	<b>27 IR 3.5 H-903</b>	2.8	3.8	7 - 85/8
3	27	5/8	1.25	<b>27 ER 3 SLH-90</b>	<b>27 IR 3 SLH-90</b>	3.3	4.6	23/8 - 31/2

Order example: 27 ER 3.5 H-903 BMA

## PAC

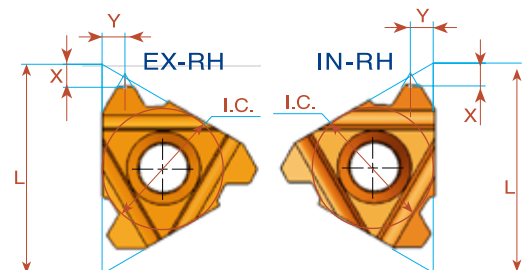
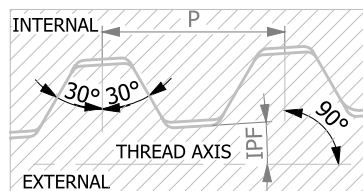

Pitch TPI	L mm	I.C.	Taper IPF	<b>EXTERNAL</b>	<b>INTERNAL</b>	X	Y	Connection No. or Size
				Ordering Code Right Hand	Ordering Code Right Hand			
4	22	1/2	1.5	<b>22 ER 4 PAC</b>	<b>22 IR 4 PAC</b>	2.3	2.3	21/2 - 27/8
4	27	5/8	1.5	<b>27 ER 4 PAC</b>	<b>27 IR 4 PAC</b>	2.3	2.3	21/2 - 27/8

Order example: 22 ER 4 PAC MXC

## NPS

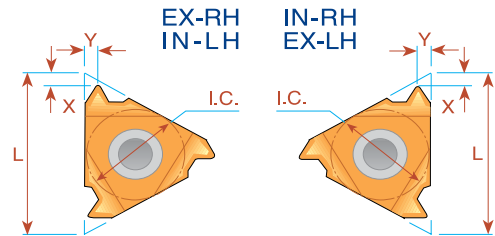
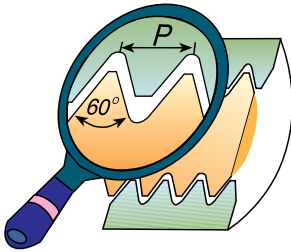

Pitch TPI	L mm	I.C.	<b>EXTERNAL</b>		<b>INTERNAL</b>		X	Y
			Right Hand	Left Hand	Right Hand	Left Hand		
18	16	3/8	<b>16 ER 18 NPS</b>	<b>16 EL 18 NPS</b>	<b>16 IR 18 NPS</b>	<b>16 IL 18 NPS</b>	0.8	1
14	16	3/8	<b>16 ER 14 NPS</b>	<b>16 EL 14 NPS</b>	<b>16 IR 14 NPS</b>	<b>16 IL 14 NPS</b>	1	1.3
11.5	16	3/8	<b>16 ER 11.5 NPS</b>	<b>16 EL 11.5 NPS</b>	<b>16 IR 11.5 NPS</b>	<b>16 IL 11.5 NPS</b>	1	1.5
8	16	3/8	<b>16 ER 8 NPS</b>	<b>16 EL 8 NPS</b>	<b>16 IR 8 NPS</b>	<b>16 IL 8 NPS</b>	1.3	1.8

Order example: 16 ER 18 NPS BMA

## NPSM

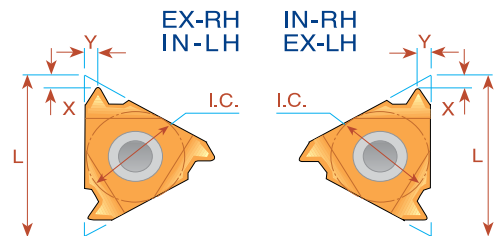
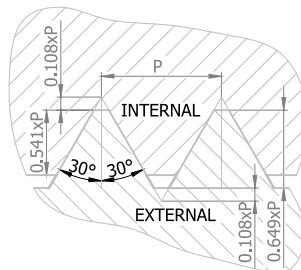

Pitch TPI	L mm	I.C.	<b>EXTERNAL</b>		X	Y	<b>INTERNAL</b>		X	Y
			Right Hand	Right Hand			Right Hand	Right Hand		
18	8	3/16					<b>08 IR 18 NPSM</b>	0.7	0.7	
18	11	1/4					<b>11 IR 18 NPSM</b>	0.8	1.0	
18	16	3/8	<b>16 ER 18 NPSM</b>		0.8	1.0				
14	16	3/8	<b>16 ER 14 NPSM</b>		1.0	1.2				
11.5	16	3/8	<b>16 ER 11.5 NPSM</b>		1.2	1.5				
8	16	3/8	<b>16 ER 8 NPSM</b>		1.3	1.6				

Order example: 16 IR 14 NPSM MXC

For carbide grade and cutting speed see page A04-2 and 3



## Vertical API

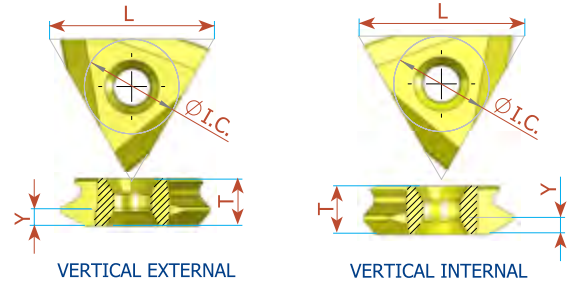
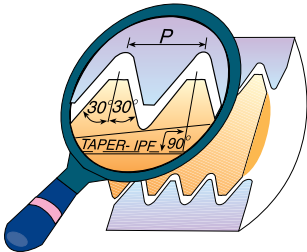

Thread Form	Pitch TPI	L	I.C. in	Taper IPF	<b>EXTERNAL</b> Ordering Code	Y	T	Connection No. or Size
V-0.040	5	27	5/8	3	<b>TNMB 54 ER 5 API 403</b>	2.5	6.4	23/8-41/2 REG
V-0.038R	4	27	5/8	2	<b>TNMC 55 ER 4 API 382</b>	2.8	7.94	NC23-NC50
V-0.038R	4	27	5/8	3	<b>TNMC 55 ER 4 API 383</b>	2.8	7.94	NC56-NC77
V-0.050	4	27	5/8	2	<b>TNMC 55 ER 4 API 502</b>	3.0	7.94	65/8 REG
V-0.050	4	27	5/8	3	<b>TNMC 55 ER 4 API 503</b>	3.0	7.94	51/2, 75/8, 85/8 REG

Vertical inserts to be used with compatible holders on the market

Order example: TNMC 55 ER 4 API 503 BMA

Thread Form	Pitch TPI	L	I.C. in	Taper IPF	<b>INTERNAL</b> Ordering Code	Y	T	Connection No. or Size
V-0.040	5	27	5/8	3	<b>TNMB 54 IR 5 API 403</b>	2.5	6.4	23/8-41/2 REG
V-0.038R	4	27	5/8	2	<b>TNMC 55 IR 4 API 382</b>	2.8	7.94	NC23-NC50
V-0.038R	4	27	5/8	3	<b>TNMC 55 IR 4 API 383</b>	2.8	7.94	NC56-NC77
V-0.050	4	27	5/8	2	<b>TNMC 55 IR 4 API 502</b>	3.0	7.94	65/8 REG
V-0.050	4	27	5/8	3	<b>TNMC 55 IR 4 API 503</b>	3.0	7.94	51/2, 75/8, 85/8 REG

Vertical inserts to be used with compatible holders on the market

Order example: TNMC 55 IR 4 API 502 BMA

## Vertical

### API Buttress Casing

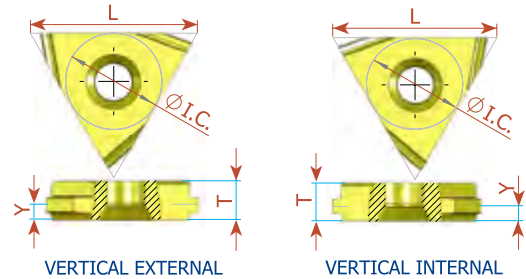
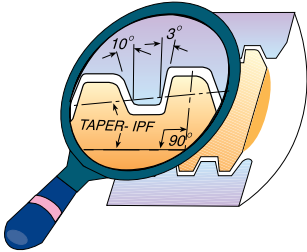

Pitch TPI	L	I.C. in	Taper IPF	<b>EXTERNAL</b> Ordering Code	Y	T	Connection No. or Size
5	27	5/8	0.75	<b>TNMB 54 ER 5 BUT 0.75</b>	2.4	6.4	4 1/2 -13 3/8
5	27	5/8	1.00	<b>TNMB 54 ER 5 BUT 1.0</b>	2.4	6.4	16 -20

Order example: TNMB 54 ER 5 BUT 1.0 BMA

Pitch TPI	L	I.C. in	Taper IPF	<b>INTERNAL</b> Ordering Code	Y	T	Connection No. or Size
5	27	5/8	0.75	<b>TNMB 54 IR 5 BUT 0.75</b>	2.4	6.4	4 1/2 -13 3/8
5	27	5/8	1.00	<b>TNMB 54 IR 5 BUT 1.0</b>	2.4	6.4	16 -20

Vertical inserts to be used with compatible holders on the market

Order example: TNMB 54 IR 5 BUT 0.75 BMA

## Vertical API Round

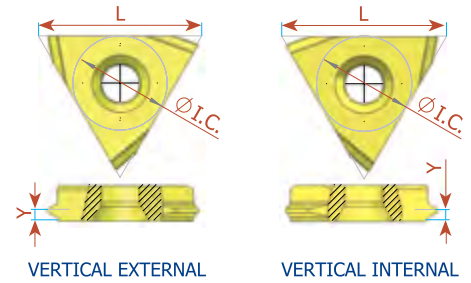
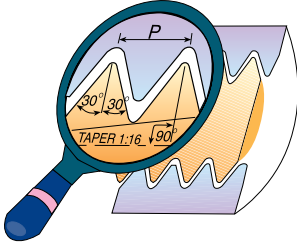

Pitch TPI	L	I.C. in	Taper IPF	<b>EXTERNAL</b> Ordering Code	Y	T
10	22	1/2	0.75	<b>TNMB 43 ER 10 API RD</b>	1.45	4.76
8	22	1/2	0.75	<b>TNMB 43 ER 8 API RD</b>	1.65	4.76

Order example: TNMB 43 ER 10 API RD BMA

Pitch TPI	L	I.C. in	Taper IPF	<b>INTERNAL</b> Ordering Code	Y	T
10	22	1/2	0.75	<b>TNMB 43 IR 10 API RD</b>	1.45	4.76
8	22	1/2	0.75	<b>TNMB 43 IR 8 API RD</b>	1.65	4.76

Vertical inserts to be used with compatible holders on the market

Order example: TNMB 43 IR 8 API RD BMA

## Chasers

### API Round

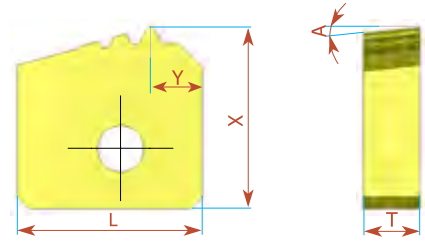

Pitch TPI	L	Taper IPF	<b>EXTERNAL</b> Ordering Code	X	Y	T	A	No. of Teeth
10	15.75	0.75	<b>15.75 ER 10 API RD 3T</b>	15.435	4.4	4.76	6°	3
8	15.75	0.75	<b>15.75 ER 8 API RD 3T</b>	15.84	4.4	4.76	6°	3

Order example: 15.75 ER 10 API RD 3T BMA

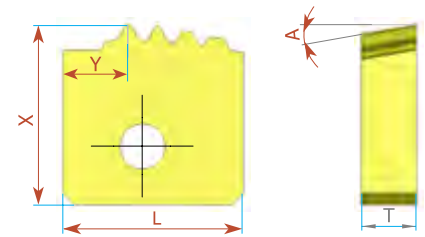

Pitch TPI	L	Taper IPF	<b>INTERNAL</b> Ordering Code	X	Y	T	A	No. of Teeth
10	15.75	0.75	<b>15.75 IR 10 API RD 4T</b>	15.75	5.7	4.76	10°	4
8	15.875	0.75	<b>15.875 IR 8 API RD 4T</b>	15.75	4.2	4.76	10°	4

Chasers to be used with compatible holders on the market

Order example: 15.75 IR 10 API RD 4T BMA

## Chasers

### API Buttress Casing

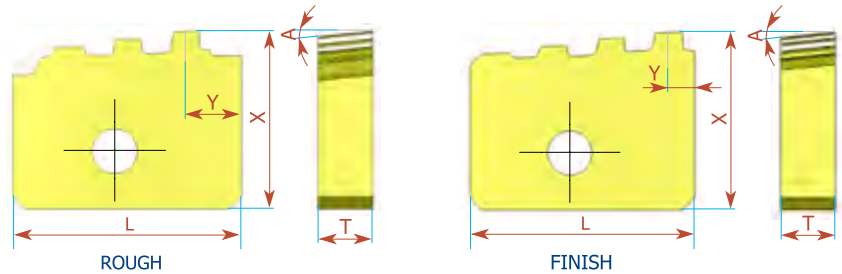

Pitch TPI	L	Taper IPF	<b>EXTERNAL</b> Ordering Code	X	Y	T	A	No. of Teeth
5	20	0.75	<b>20 ER 5 BUT 0.75R</b>	15.692	4.84	4.76	6°	3
5	20	0.75	<b>20 ER 5 BUT 0.75F</b>	15.875	2.3	4.76	6°	4

Order example: 20 ER 5 BUT 0.75F BMA

## Chasers

### OTTM Buttress Casing

Pitch TPI	L	Taper IPF	<b>EXTERNAL</b> Ordering Code	X	Y	T	A	No. of Teeth
5	20	0.75	<b>20 ER 5 OTTM 0.75R</b>	15.692	4.79	4.76	6°	3
5	20	0.75	<b>20 ER 5 OTTM 0.75F</b>	15.909	2.25	4.76	6°	4

Chasers to be used with compatible holders on the market

Order example: 20 ER 5 OTTM 0.75F BMA

## Chasers

### API Buttress Casing

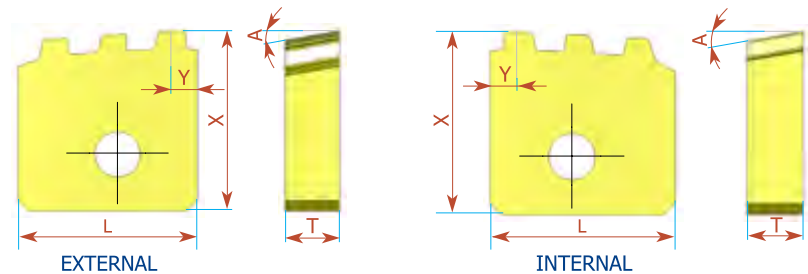

Pitch TPI	L	Taper IPF	<b>EXTERNAL</b> Ordering Code	X	Y	T	A	No. of Teeth
5	15.75	0.75	<b>15.75 ER 5 BUT 0.75 3T</b>	15.875	2.3	4.76	10°	3

Pitch TPI	L	Taper IPF	<b>INTERNAL</b> Ordering Code	X	Y	T	A	No. of Teeth
5	15.875	0.75	<b>15.875 IR 5 BUT 0.75 3T</b>	15.75	2.5	4.76	10°	3

Order example: 15.75 ER 5 BUT 0.75 3T BMA

## Chasers

### OTTM Buttress Casing

Pitch TPI	L	Taper IPF	<b>EXTERNAL</b> Ordering Code	X	Y	T	A	No. of Teeth
5	15.75	0.75	<b>15.75 ER 5 OTTM 0.75 3T</b>	15.75	3.0	4.76	6°	3

Pitch TPI	L	Taper IPF	<b>INTERNAL</b> Ordering Code	X	Y	T	A	No. of Teeth
5	15.875	0.75	<b>15.875 IR 5 OTTM 0.75 3T</b>	15.875	2.5	4.76	10°	3

Chasers to be used with compatible holders on the market

Order example: 15.75 ER 5 OTTM 0.75 3T BMA

## Chasers

### API Buttress Casing

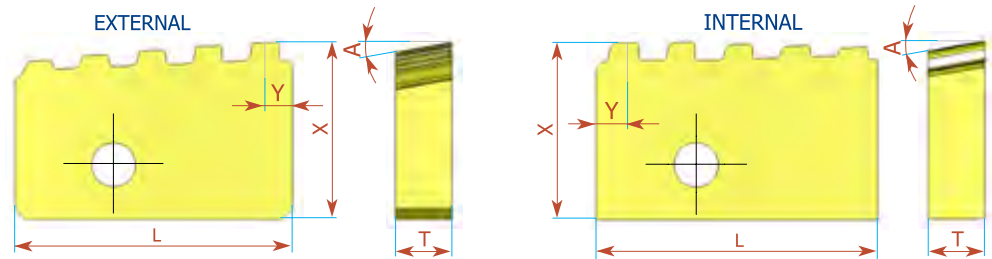

Pitch TPI	L	Taper IPF	<b>EXTERNAL</b> Ordering Code	X	Y	T	A	No. of Teeth
5	25	0.75	<b>25 ER 5 BUT 0.75 5T</b>	15.871	2.5	5	10°	5

Pitch TPI	L	Taper IPF	<b>INTERNAL</b> Ordering Code	X	Y	T	A	No. of Teeth
5	25	0.75	<b>25 IR 5 BUT 0.75 5T</b>	15.875	2.5	5	10°	5

Order example: 25 IR 5 BUT 0.75 5T BMA

## Chasers

### OTTM Buttress Casing

Pitch TPI	L	Taper IPF	<b>INTERNAL</b> Ordering Code	X	Y	T	A	No. of Teeth
5	25	0.75	<b>25 IR 5 OTTM 0.75 5T</b>	15.75	2.5	5	10°	5

Chasers to be used with compatible holders on the market

Order example: 25 IR 5 OTTM 0.75 5T BMA



## Chasers

### API Buttress Casing

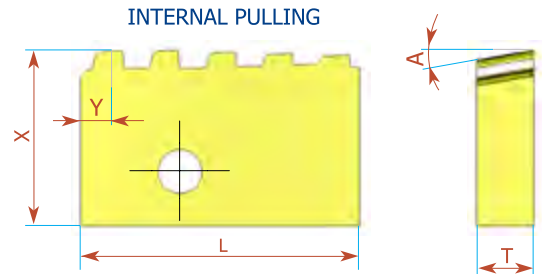

Pitch TPI	L	Taper IPF	<b>INTERNAL</b> Ordering Code	X	Y	T	A	No. of Teeth
5	25	0.75	<b>25 IRP 5 BUT 0.75 5T</b>	15.75	2.5	5	10°	5

Order example: 25 IRP 5 BUT 0.75 5T BMA

## Chasers

### OTTM Buttress Casing

Pitch TPI	L	Taper IPF	<b>INTERNAL</b> Ordering Code	X	Y	T	A	No. of Teeth
5	25	0.75	<b>25 IRP 5 OTTM 0.75 5T</b>	15.75	2.5	5	10°	5

Chasers to be used with compatible holders on the market

Order example: 25 IRP 5 OTTM 0.75 5T BMA

## Large Profile Inserts and Toolholders

- Wide range of pitches
- Rigid clamping
- Tailor made profiles according to customer's request are possible



*External*

*Internal*

## Large Profile Inserts

### Trapez - DIN 103

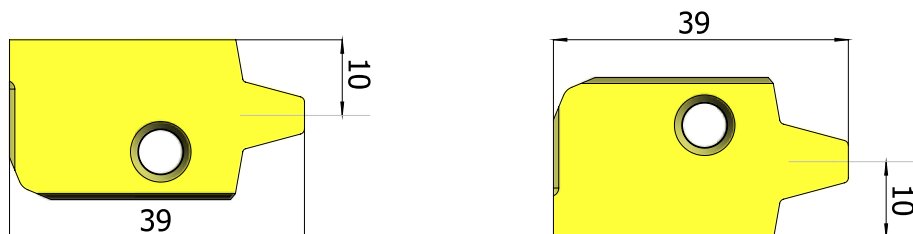

Pitch mm	Ordering Code EX RH	Holder Code	Ordering Code EX LH	Holder Code	Ordering Code IN RH	Holder Code	Ordering Code IN LH	Holder Code
14	40 ER 14 TR	H1	40 EL 14 TR	H2	40 IR 14 TR	H7, 6	40 IL 14 TR	H8, 5
16	40 ER 16 TR		40 EL 16 TR		40 IR 16 TR		40 IL 16 TR	
18	40 ER 18 TR		40 EL 18 TR		40 IR 18 TR		40 IL 18 TR	
20	40 ER 20 TR	H3	40 EL 20 TR	H4	40 IR 20 TR	H9	40 IL 20 TR	H10
22	40 ER 22 TR		40 EL 22 TR		40 IR 22 TR		40 IL 22 TR	
24	40 ER 24 TR		40 EL 24 TR		40 IR 24 TR		40 IL 24 TR	

Carbide grade: BMA or MXC

Order example: 40 ER 18 TR BMA

## External Holders

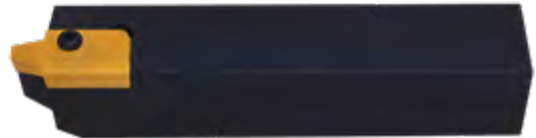
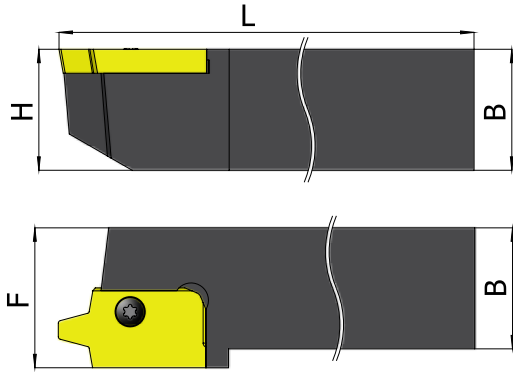

Pitch Range (mm) 14, 16, 18 Ordering Code		B=H	L	F	Insert Screw	Torx Screw	Holder No.
EX-RH	<b>SER 3232 P40</b>	32	170	32	S40	K40	H1
EX-LH	<b>SEL 3232 P40</b>	32	170	32	S40	K40	H2

Pitch Range (mm) 20, 22, 24 Ordering Code		B=H	L	F	Insert Screw	Side Screw	Torx Screw	Holder No.
EX-RH	<b>SER 3232 P40T</b>	32	170	32	S40	A27	K40	H3
EX-LH	<b>SEL 3232 P40T</b>	32	170	32	S40	A27	K40	H4

Pitch Range (mm) 14, 16, 18 Ordering Code		B=H	L	F	Insert Screw	Torx Screw	Holder No.
EX-RH	<b>SER 2525 M40</b>	25	150	32	S40	K40	*H5
EX-LH	<b>SEL 2525 M40</b>	25	150	32	S40	K40	*H6

\* H5 and H6 toolholders to be used with toolbar provided by the customer

## Internal Holders

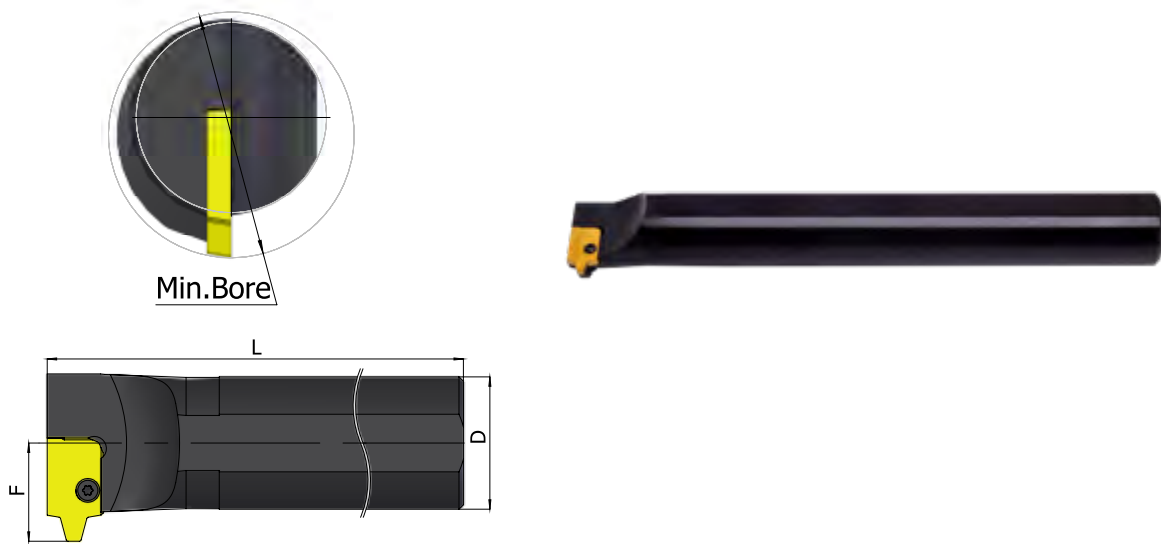

Pitch Range (mm) 14, 16, 18 Ordering Code		D	Min Bore Diam.	L	F	Insert Screw	Torx Screw	Holder No.
IN-RH	<b>SIR 0050 V40</b>	50	70	400	37	S40	K40	H7
IN-LH	<b>SIL 0050 V40</b>	50	70	400	37	S40	K40	H8

Pitch Range (mm) 20, 22, 24 Ordering Code		D	Min Bore Diam.	L	F	Insert Screw	Side Screw	Torx Screw	Holder No.
IN-RH	<b>SIR 0050 V40T</b>	50	70	400	37	S40	A27	K40	H9
IN-LH	<b>SIL 0050 V40T</b>	50	70	400	37	S40	A27	K40	H10

## Large Profile Sagengewinde Inserts

### DIN 513

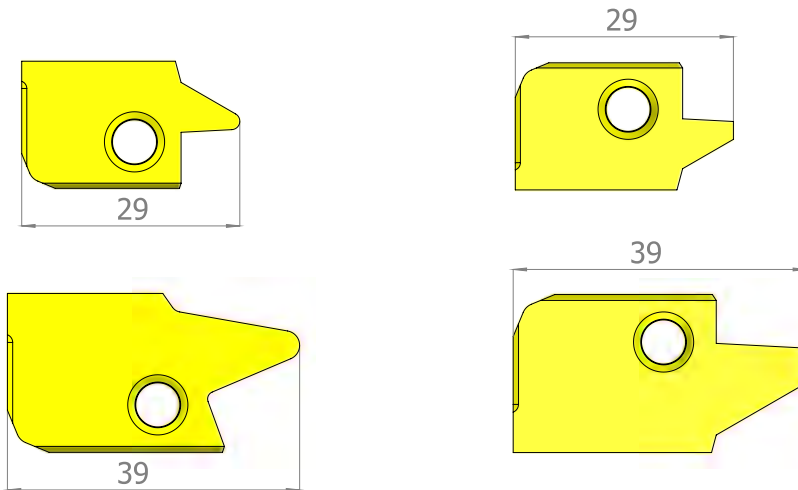

Pitch mm	Ordering Code EX RH	Holder Code	Ordering Code IN RH	Holder Code
9	<b>30 ER 9 SAGE</b>	S1, 2	<b>30 IR 9 SAGE</b>	S7
10	<b>40 ER 10 SAGE</b>	S3, 4	<b>40 IR 10 SAGE</b>	S8
12	<b>40 ER 12 SAGE</b>	S3, 4	<b>40 IR 12 SAGE</b>	S9
14	<b>40 ER 14 SAGE</b>	S5	<b>40 IR 14 SAGE</b>	S10
16	<b>40 ER 16 SAGE</b>	S6	<b>40 IR 16 SAGE</b>	S11

Carbide grade: BMA or MXC

Order example: 40 ER 10 SAGE MXC

Additional profiles upon request

Round (DIN 20400)

Acme, Stub Acme

American Buttress

## External Holders

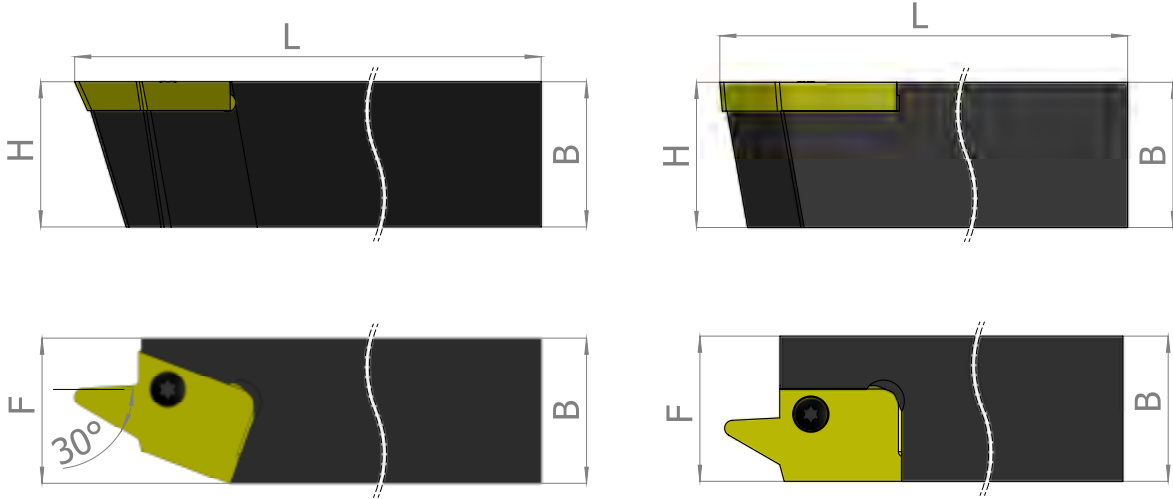

Version A

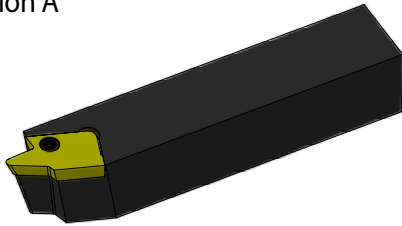

Version B

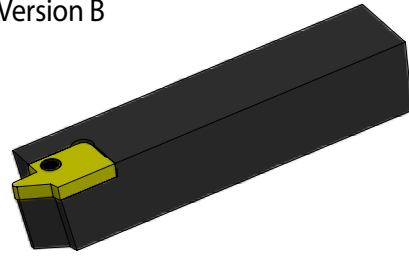

The flank with the large angle is the leading edge

Ordering Code		B=H	L	F	Insert Screw	Torx Screw	Version	Holder No.
EX-RH	<b>SER 2525 M30</b>	25	150	25	S30	K30	B	S1
	<b>SER 3232 P30</b>	32	170	32	S30	K30	B	S2
	<b>SER 2525 M40T</b>	25	150	25	S40	K40	B	S3
	<b>SER 3232 P40S</b>	32	170	32	S40	K40	B	S4
	<b>SER 3232 P40W</b>	32	170	32	S40	K40	B	S5
	<b>SER 3232 P40Q</b>	32	170	32	S40	K40	A	S6

## Internal Holders

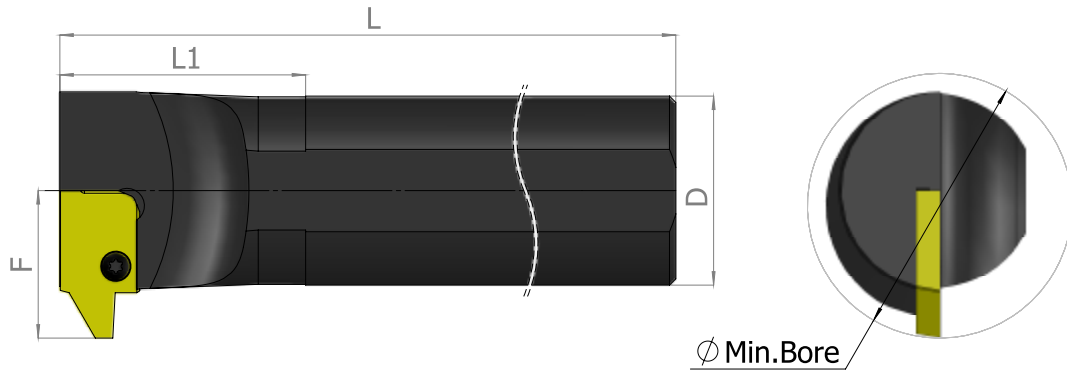

Ordering Code	D	Min Bore Diam.	L	L1	F	Insert Screw	Torx Screw	Holder No.
<b>SIR 0032 S30</b>	32	40.0	250	120	24.0	S30	K30	S7
<b>SIR 0040 T40</b>	40	49.0	300	140	28.0	S40	K40	S8
IN-RH <b>SIR 0050 U40</b>	50	65.0	350	-	35.0	S40	K40	S9
<b>SIR 0060 V40</b>	60	80.0	400	-	41.0	S40	K40	S10
<b>SIR 0060 V40T</b>	60	80.0	400	-	43.0	S40	K40	S11